

cinquanta3

stanze
su misura

accoglienti
e funzionali

presenta

home
spaces



home spaces
presents custom,
cosy and functional
rooms planned using
the flexibility and
extensive modularity
of cinquanta3.

manifesto p. 2

living rooms p. 4

bedrooms p. 74

utility rooms p. 164

**elements,
technical data** p. 212

**home
spaces**

MANIFESTO

cinquanta3 nasce per rispondere alle tendenze ed esigenze del vivere contemporaneo che invita a ricercare soluzioni funzionali e flessibili, capaci di organizzare e contenere, definire e interpretare gli spazi del quotidiano. Un nuovo sistema d'arredo dove la massima libertà compositiva è garantita da ampia modularità e tonalità neutre, e la personalizzazione degli ambienti si esprime nella gamma di accessori e nella versatilità dei prodotti.

In **home spaces** gli elementi d'arredo diventano strutture architettoniche che creano nuove forme di contenimento, capaci di definire i diversi luoghi della casa e accogliere le passioni e la storia di chi li vive.

cinquanta3 was conceived as a response to contemporary lifestyle trends and demands, prompting us to find functional, flexible solutions capable of organizing and storing, defining and interpreting our everyday spaces. A new furniture system whose ultimate modular design and neutral shades ensure the utmost compositional freedom, while an extensive range of accessories and product versatility allow you to put your personal stamp on interiors.

In **home spaces**, the furniture takes on the role of architectural structures that create new forms of containment, capable of defining the home's different rooms and accommodating the occupants' passions and story.

zone giorno razionali

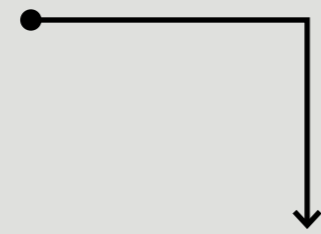

progettate per contenere

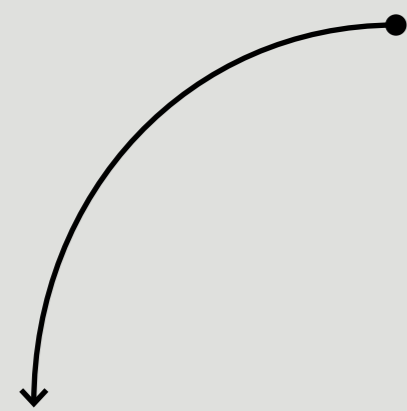

trasformare

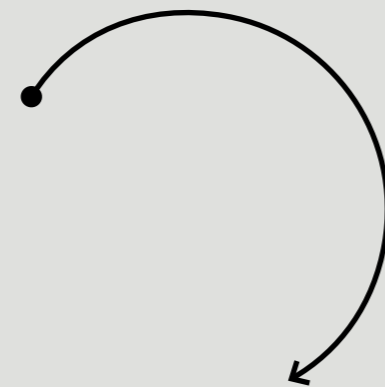

e ridefinire gli spazi

rational living
areas designed
to contain, transform
and redefine spaces.

L1



p. 6

L2



p. 16

L3



p. 24

L4



p. 34

L5



p. 40

L6



p. 52

L7



p. 62

LI

A
libreria a terra con vani a giorno e ante Liscia battenti in finitura olmo shade, apertura push-pull.

floorstanding bookcase with open shelving and hinged Plain doors in olmo shade finish, push-to-open system.

B
pensili ante a rialza in finitura cashmere, apertura push-pull, e ante vetro trasparente.

wall units with lift-up doors in cashmere finish, push-to-open system, and transparent glass doors.

C
basi a terra con top e cassettoni in finitura nuvola e maniglie A47 in finitura brunito.

floorstanding base units with top and oversized drawers in nuvola finish and A47 handles in bronze finish.

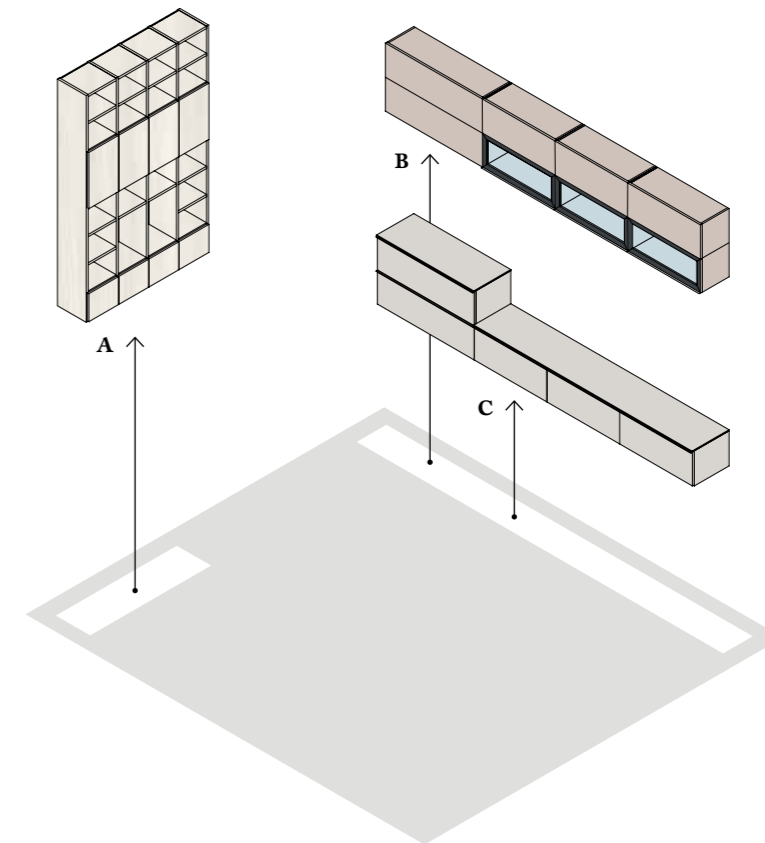

A
libreria
a terra
—
floorstanding
bookcase

L—W 183 cm
H 294,5 cm
P—D 45,4 cm





B — KEY PRODUCT

pensili
—
wall units

L — W 390 cm
H 73,2 cm
P — D 35,4 cm



C — KEY PRODUCT

**basi a terra
con top**

**—
floorstanding
base units
with top**

L — W 390 cm
H 76,1 | 39,5 cm
P — D 45,8 cm

KEY PRODUCT

LI.1



Basi a terra e sospese con top, cassetto e cassettoni in finitura olmo nordico apertura push-pull, **pensili** ante battenti vetro fumè, scocca in finitura nuvola.

Floorstanding and wall-mounted base units with top and with push-to-open drawer and oversized drawers in olmo nordico finish, **wall units** with smoked glass hinged doors, carcass in nuvola finish.

LI.2



Basi sospese con top e cassetti in finitura cashmere, **pensili** ante battenti in finitura sabbia, apertura push-pull, **casellari** in finitura olmo nordico.

Wall-mounted base units with top and drawers in cashmere finish, **wall units** with push-to-open hinged doors in sabbia finish, **open wall units** in olmo nordico finish.

L2

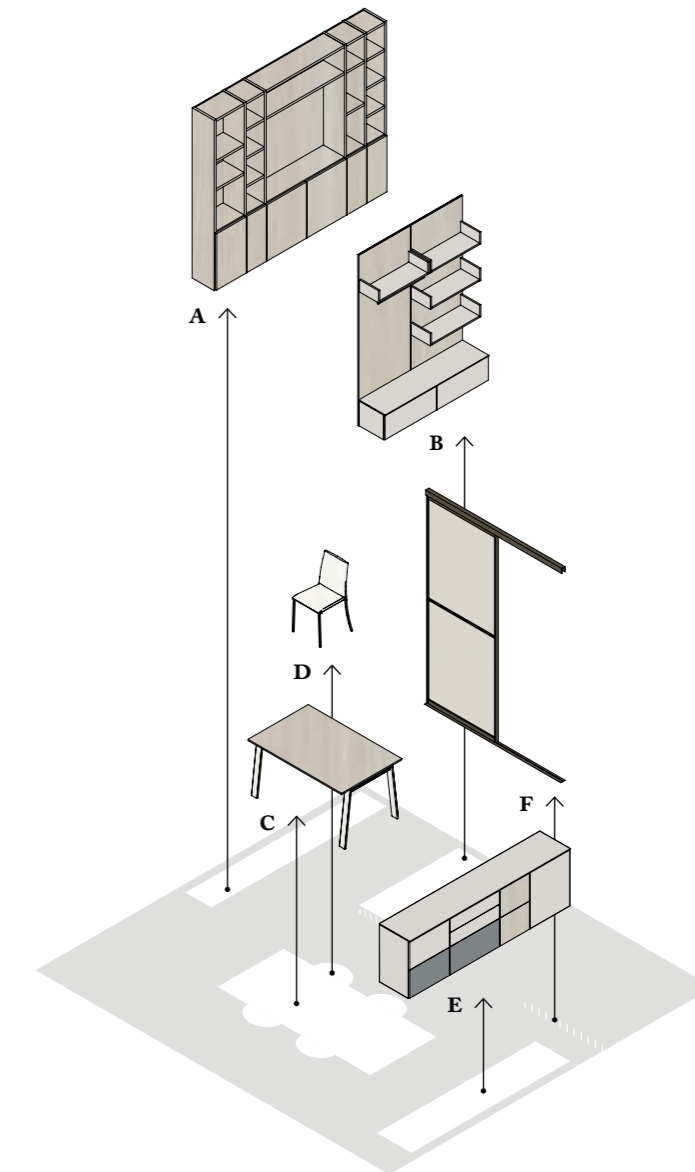
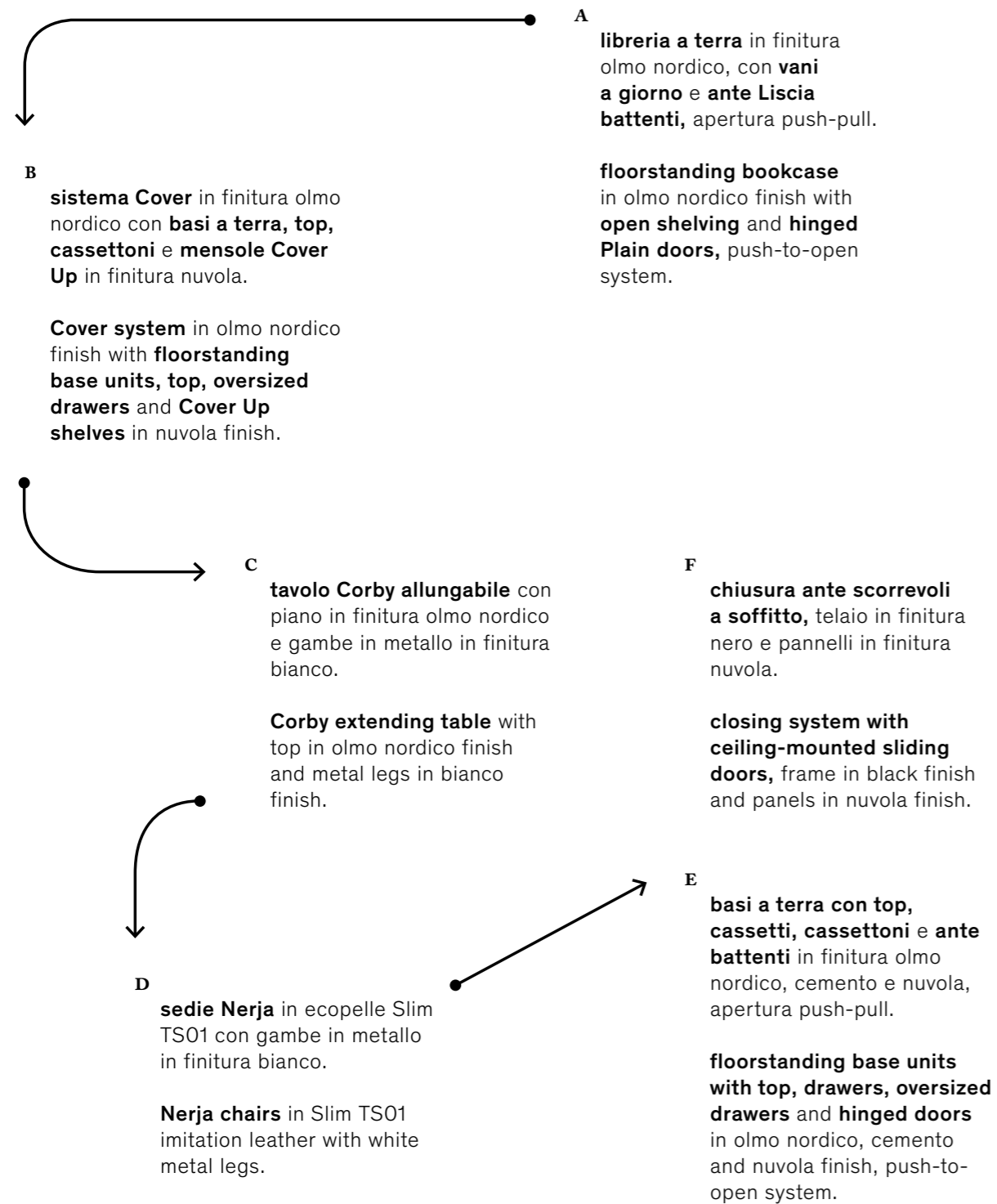



A

libreria a terra
—
floorstanding
bookcase

L—W 258 cm
H 221,3 cm
P—D 35,4 cm



B

sistema Cover,
basi a terra
con top e mensole
Cover Up

—
Cover system,
floorstanding base
units with top and
Cover Up shelves

L—W 150 cm
H 257,9 cm
P—D 45,8 cm



F

chiusura ante
scorrevoli
a soffitto
—
closing system
with ceiling-
mounted
sliding doors

L—W 184 cm
H 270 cm
P—D 4,5 cm

C, D

tavolo Corby
e sedie Nerja
—
Corby table
and Nerja chairs

L—W 140/260 cm
H 75 cm
P—D 90 cm



E — KEY PRODUCT

**basi a terra
con top
—
floorstanding
base units
with top**

L—W 240 cm
H 76,1 cm
P—D 45,8 cm

KEY PRODUCT

L2.1



Basi a terra con top
in finitura nuvola
con ante battenti e
cassettoni apertura
push-pull e ante
ribalta vetro fumè.

**Floorstanding
base units with
top** in nuvola finish
with push-to-open
hinged doors and
oversized drawers
and smoked glass
pull-down doors.

L2.2



Basi a terra con
cassetti e cassettoni
in finitura basalto,
apertura push-pull,
con **top** in finitura
olmo nordico.

**Floorstanding
base units** with
push-to-open
drawers and
oversized drawers
in basalto finish,
with **top** in olmo
nordico finish.

L3

A
armadio mansardato ante
Liscia battenti e maniglie A53
 in finitura bianco.

wardrobe cut to accommodate
staircase with hinged Plain
doors and A53 handles in
 bianco finish.

B
libreria a terra ed elementi
Sudoku in finitura bianco.

floorstanding bookcase
 and **Sudoku units** in bianco
 finish.

C
scrivania con piano in
 finitura lavagna e gambe
 in metallo in finitura brunito.

desk with top in lavagna
 finish and metal legs in
 bronze finish.

D
libreria bifacciale in finitura
 bianco con **ante Liscia**
battenti in finitura olmo
 nordico, apertura push-pull.

double-sided bookcase
 in bianco finish with **hinged**
Plain doors in olmo nordico
 finish, push-to-open system.

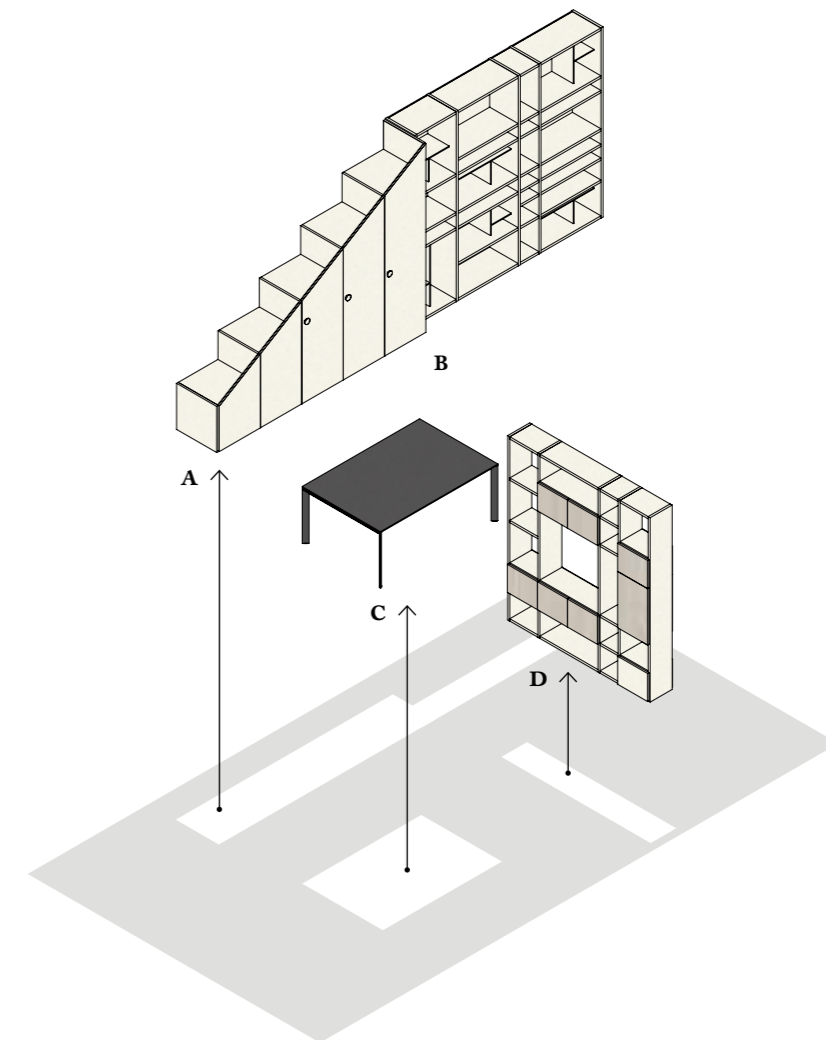



A

armadio
mansardato
ante battenti
—
hinged door
wardrobe cut
to accommodate
staircase

L—W 302,5 cm
H 57 | 239,6 cm
P—D 60,6 cm



C

scrivania
—
desk

L—W 180 cm
H 75 cm
P—D 120 cm

B — KEY PRODUCT

**libreria a terra
ed elementi
Sudoku**
—
**floorstanding
bookcase and
Sudoku units**

L—W 273 cm
H 239,6 cm
P—D 45,4 cm



KEY PRODUCT

L3.1



Libreria a terra
con vani a giorno
in finitura sabbia ed
elementi Sudoku
in finitura cashmere.

**Floorstanding
bookcase** with open
shelving in sabbia
finish and **Sudoku
units** in cashmere
finish.

L3.2



Libreria a terra
con vani a giorno
in finitura olmo
nordico con schiena
ed **elementi
Sudoku** in finitura
basalto.

**Floorstanding
bookcase** with
open shelving in
olmo nordico finish
with back panel and
Sudoku units in
basalto finish.

D — KEY PRODUCT

libreria bifacciale — double-sided bookcase

L — W 213 cm
H 239,6 cm
P — D 35,4 cm



KEY PRODUCT

L3.3



Libreria bifacciale
in finitura frassino
juta.

**Double-sided
bookcase** in
frassino juta finish.

L4

A
pensili ante battenti e a rialza e casellari in finitura basalto e canapa, apertura push-pull.

wall units with hinged and pull-up doors and open wall units in basalto and canapa finish, push-to-open system.

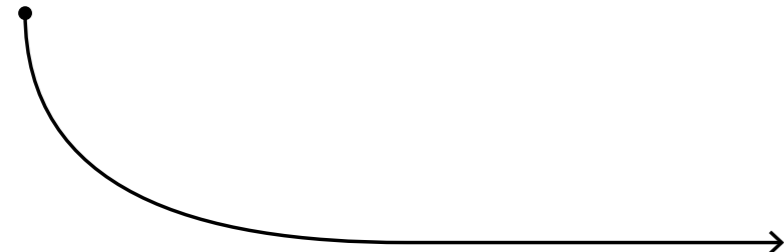

B
basi a terra con top e cassettoni in finitura olmo tabacco con serratura cilindrica.

floorstanding base units with top and oversized drawers in olmo tabacco finish with cylindrical lock.



C
scrivania con fissaggio a parete, con piano in finitura olmo tabacco e gambe in metallo in finitura brunito.

wall-mounted desk, with top in olmo tabacco finish and metal legs in bronze finish.

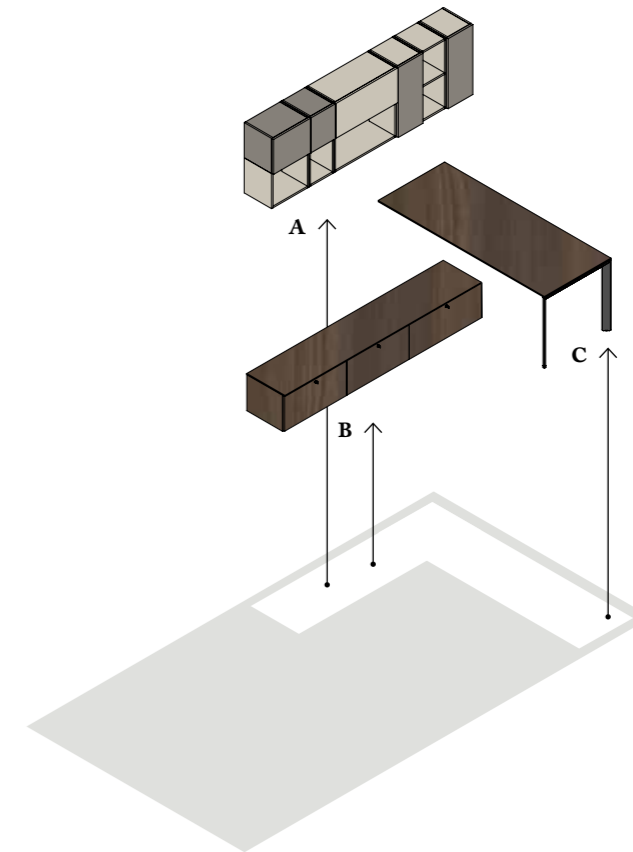

A

pensili
e casellari
—
closed and
open wall units

L—W 240 cm
H 73,2 cm
P—D 35,4 cm

B

basi a terra
con top
—
floorstanding
base units
with top

L—W 240 cm
H 39,5 cm
P—D 45,8 cm



C — KEY PRODUCT

scrivania con fissaggio a parete — wall-mounted desk

L—W 200 cm
H 75 cm
P—D 80 cm



KEY PRODUCT

L4.1



Scrivania, spessore 5 cm, in finitura nuvola, **cassettiera** e maniglie A53 in finitura canapa. Ruote della cassettera, **libreria sospesa** e **a terra** in finitura lavagna, **sedia Sneek** imbottita in Feltro TF02 con basamento R1 in metallo in finitura bianco.

Desk, 5 cm thick, in nuvola finish, **drawer unit** and A53 handles in canapa finish. Drawer unit castors, **wall-mounted** and **floorstanding bookcases** in lavagna finish, **Sneek chair** upholstered in Felt TF02 with white metal R1 base.

L4.2



Piano sospeso con alzata e mensole spessore 5 cm in finitura canapa. **Basi a terra con top** in finitura olmo tabacco con maniglie A47 in finitura brunito, **sedia Sneek** bianca con basamento R1 in metallo in finitura bianco.

Wall-mounted top with upstand and shelves 5 cm thick in canapa finish. **Floorstanding base units with top** in olmo tabacco finish with A47 handles in bronze finish, white **Sneek chair** with white metal R1 base.

L5

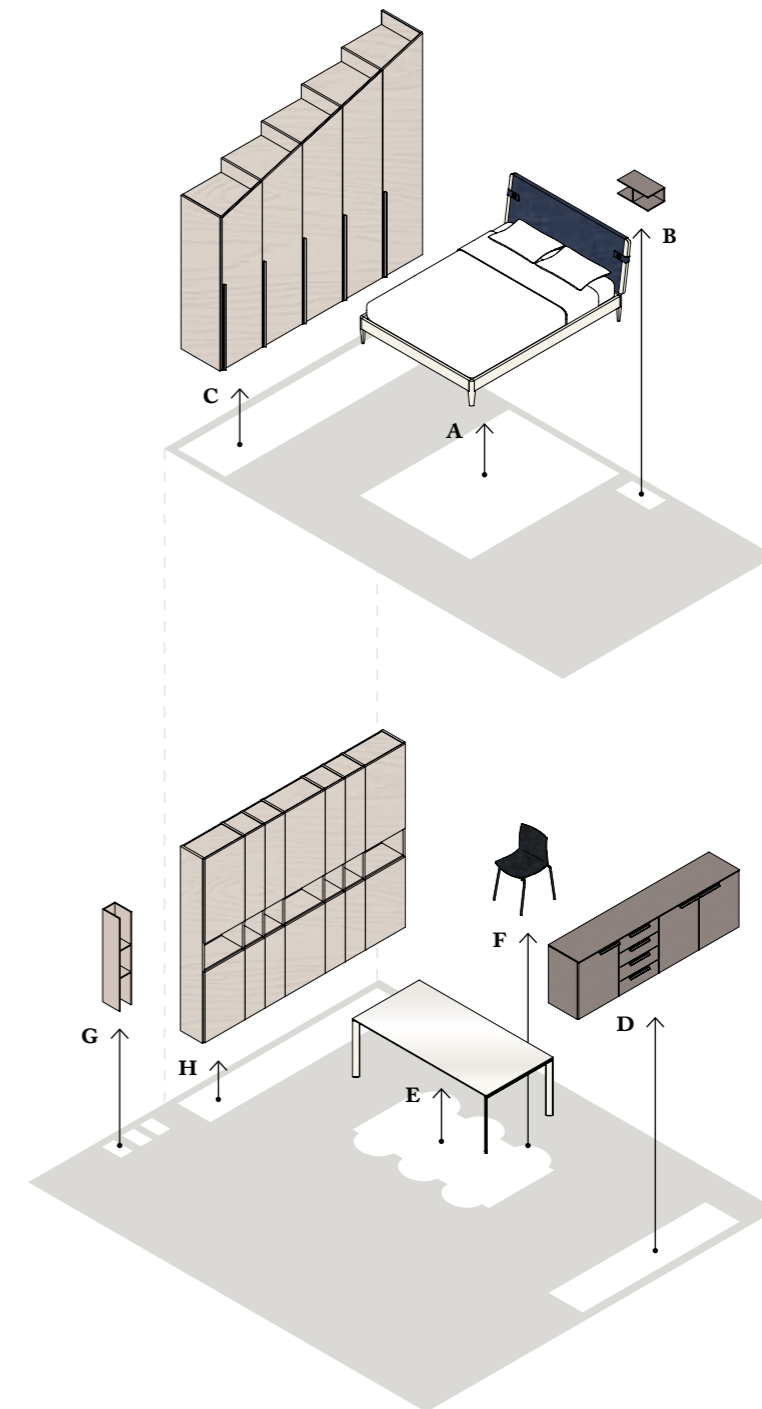
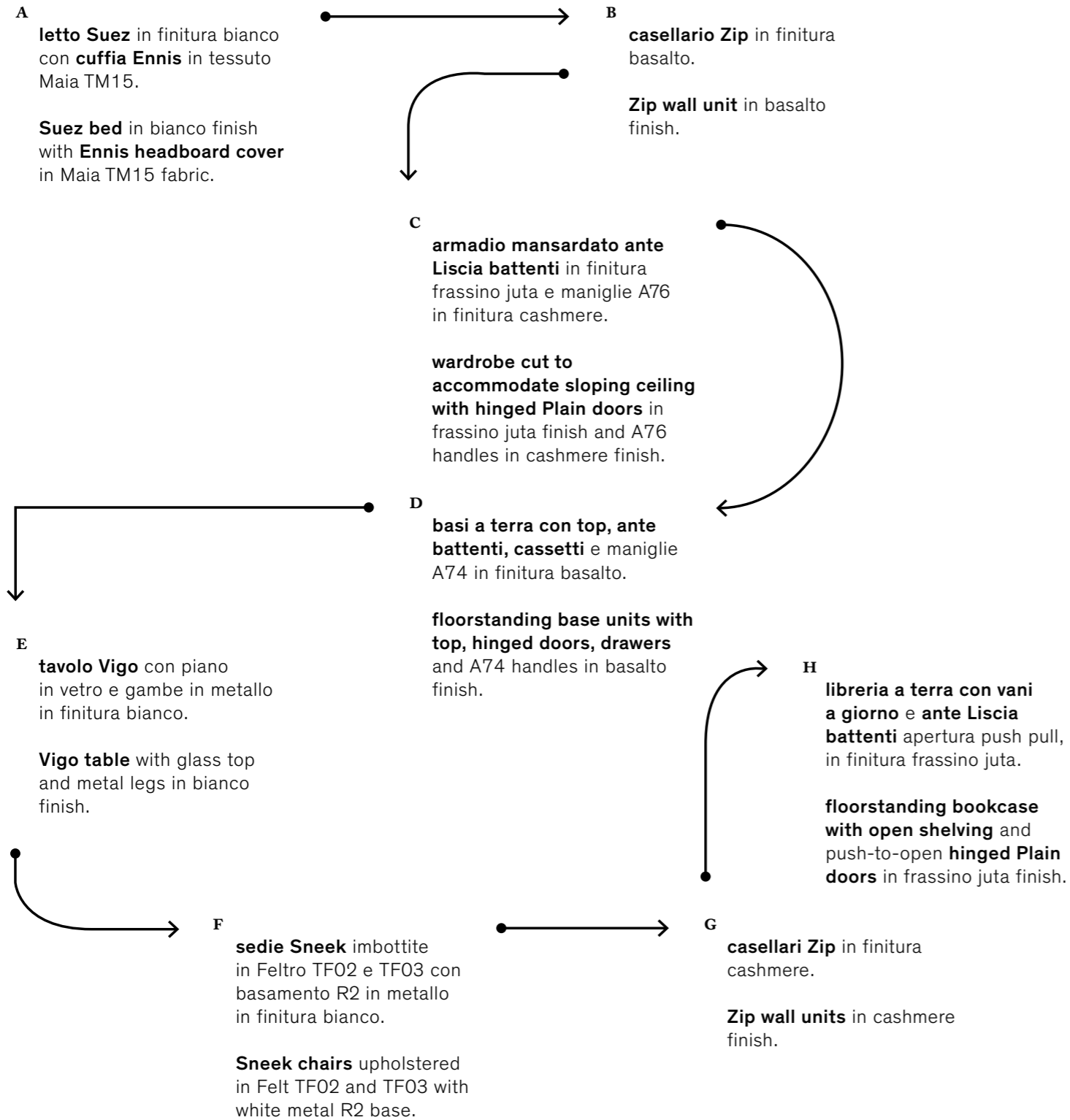



A

letto Suez con
cuffia Ennis
—
Suez bed with
Ennis headboard
cover

L—W 168 cm
H 90 cm
P—D 216 cm



B

casellario Zip
—
Zip wall unit

L—W 45 cm
H 18,3 cm
P—D 25 cm

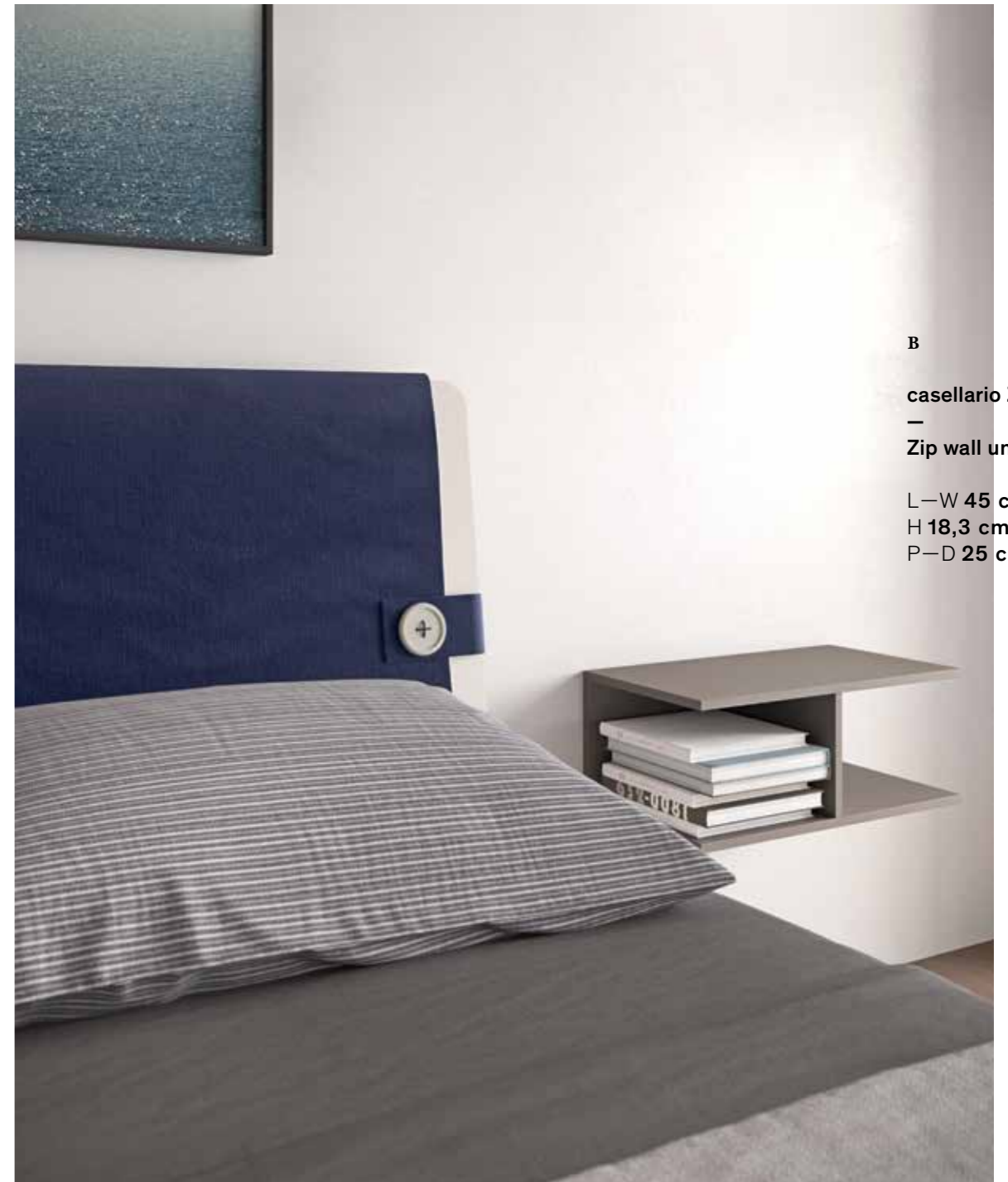

C

armadio
mansardato
ante battenti
—
hinged door
wardrobe cut
to accommodate
sloping ceiling

L—W 302,5 cm
H 179 | 280 cm
P—D 60,6 cm



D

basi a terra
con top
—
floorstanding base
units with top

L—W 240 cm
H 76,1 cm
P—D 45,8 cm



E, F

tavolo Vigo
e sedie Sneek
—
Vigo table and
Sneek chairs

L—W 200 cm
H 75 cm
P—D 100 cm

G

casellari Zip
—
Zip wall units

L—W 18,3 cm
H 120 cm
P—D 25 cm

H — KEY PRODUCT

libreria a terra
—
floorstanding
bookcase

L—W 330 cm
H 239,6 cm
P—D 35,4 cm



KEY PRODUCT

L5.1



Libreria a terra con vani a giorno in finitura bianco, ante battenti in vetro fumè, cassettoni e maniglie A75 in finitura basalto.

Floorstanding bookcase with open shelving in bianco finish, smoked glass hinged doors, oversized drawers and A75 handles in basalto finish.

L5.2



Libreria a terra con vani a giorno in finitura nuvola, ante battenti in vetro trasparente.

Floorstanding bookcase with open shelving in nuvola finish, transparent glass hinged doors.

L6

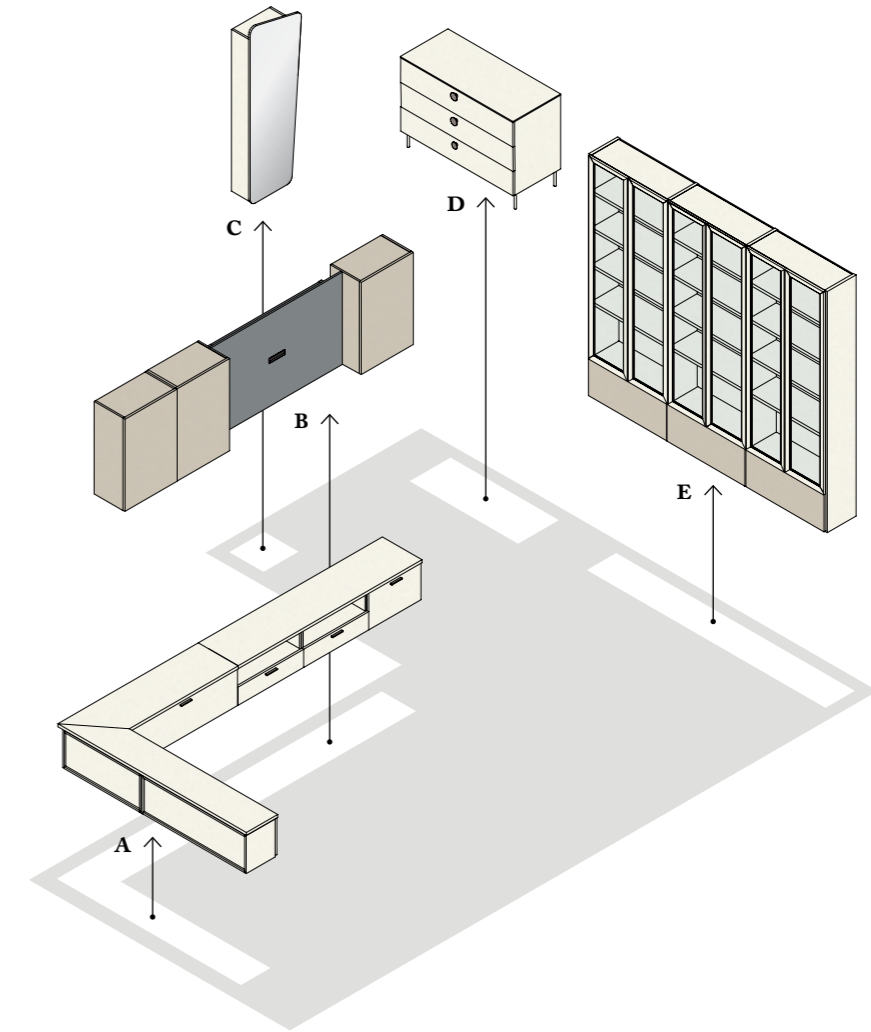
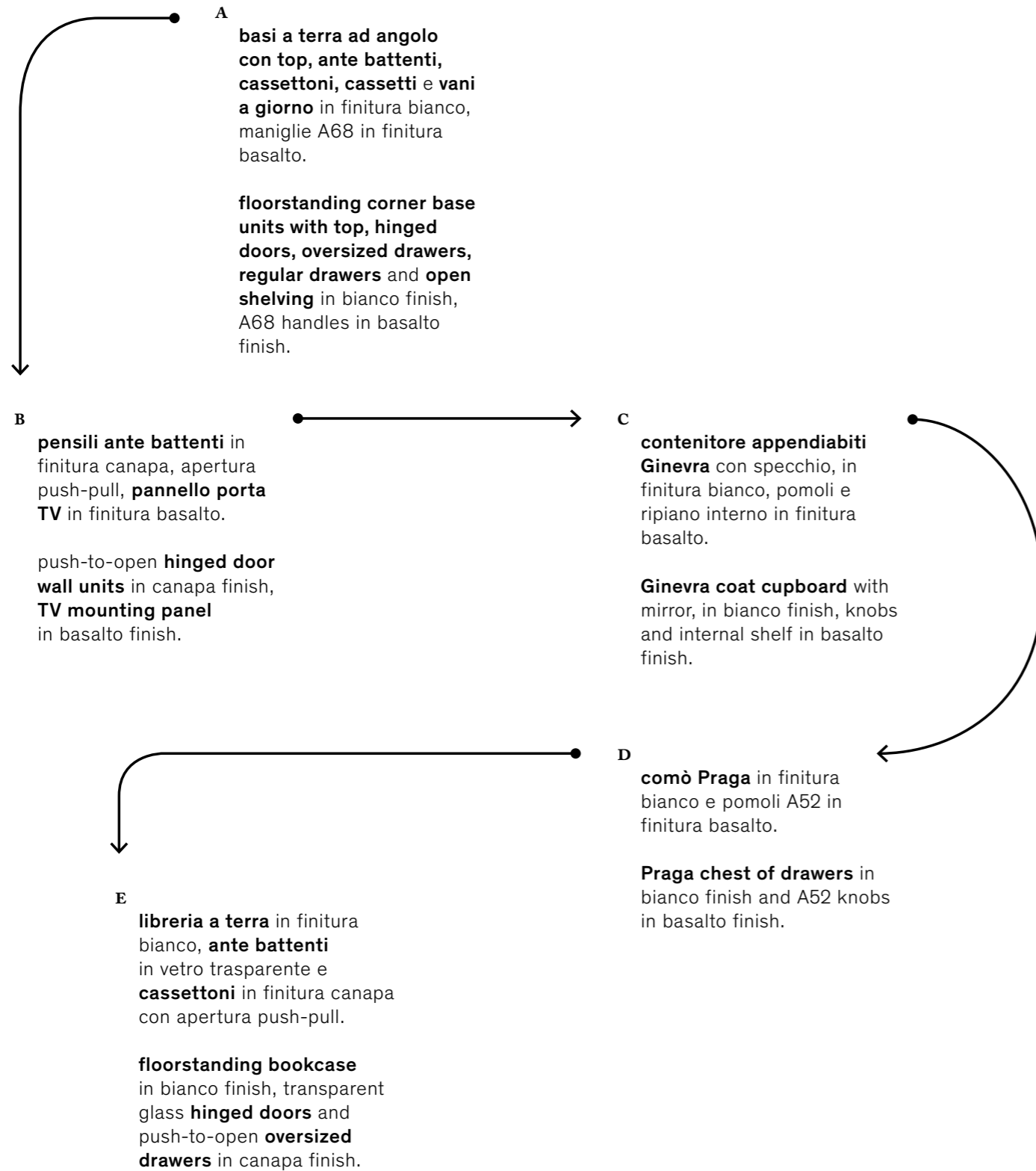

A, B — KEY PRODUCT

**basi a terra
ad angolo
con top,
pensili e
pannello
porta TV**

**—
floorstanding
corner base
units with top,
wall units and
TV mounting
panel**

L—W 380,4 cm
H 41,3 cm
P—D 45,8 cm

L—W 330 cm
H 91,5 cm
P—D 35,4 cm





C
 contenitore
 appendiabiti
 Ginevra con
 specchio
 —
 Ginevra coat
 cupboard with
 mirror
 L—W 58,6 cm
 H 175 cm
 P—D 22,4 cm

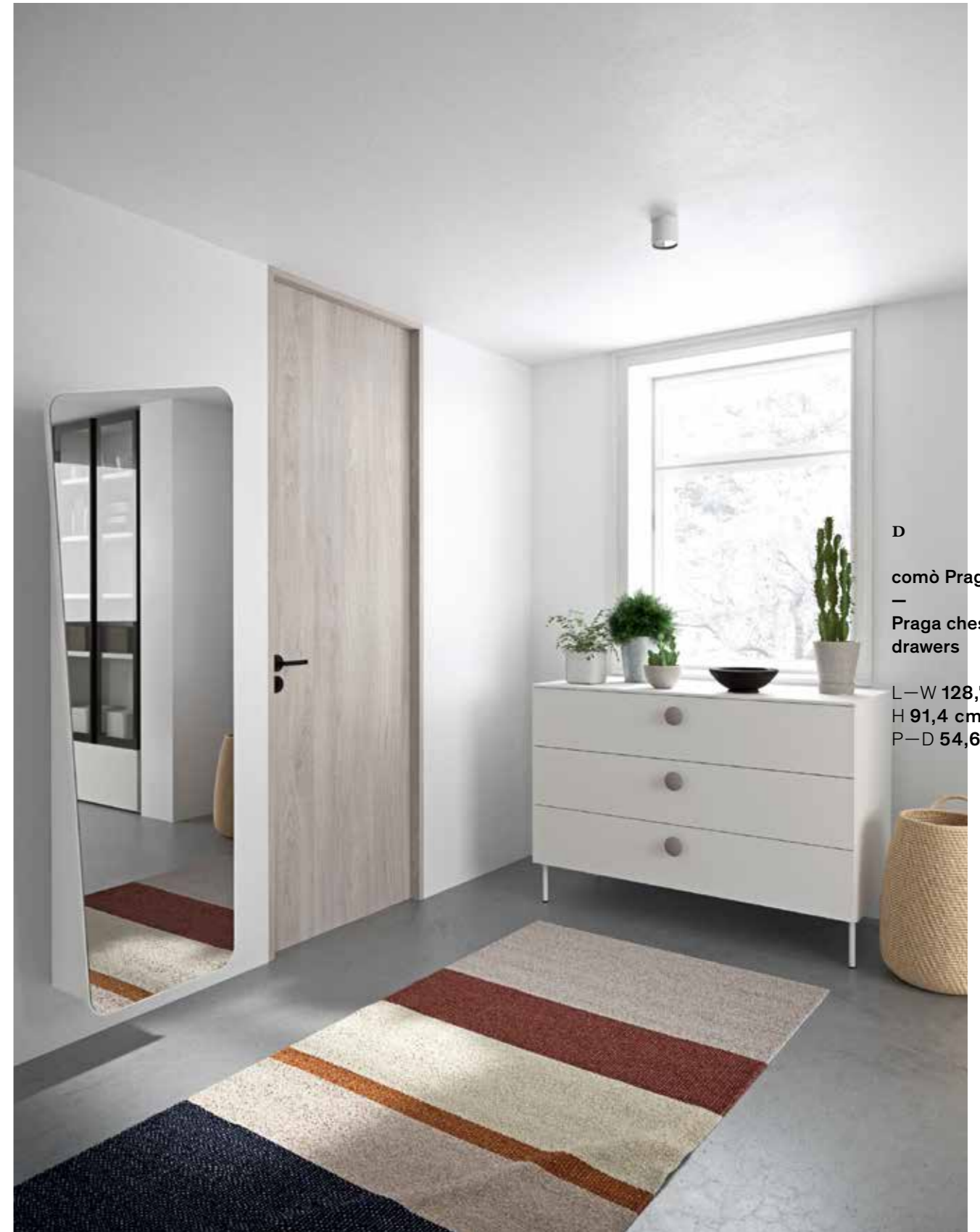

D
 comò Praga
 —
 Praga chest of
 drawers
 L—W 128,7 cm
 H 91,4 cm
 P—D 54,6 cm



E

libreria a terra
—
floorstanding
bookcase

L—W 273 cm
H 239,6 cm
P—D 35,4 cm

KEY PRODUCT

L6.1



Pannello porta TV, basi a terra con top e cassettoni in finitura sabbia, maniglie A28 in finitura basalto. **Libreria a terra, sovrapposta e sospesa** in finitura olmo nordico.

TV mounting panel, floorstanding base units with top and oversized drawers in sabbia finish, A28 handles in basalto finish. **Floorstanding, sit-on-top** and **wall-mounted bookcase** in olmo nordico finish.

L6.2



Pannello porta TV, pensili e basi a terra con top in finitura cashmere, ante con apertura push-pull nella medesima finitura e vetro fumè. **Casellari Zip** in finitura basalto. Aperture ante: pensili a rialza e basi a ribalta.

TV mounting panel, wall units and floorstanding base units with top in cashmere finish, push-to-open doors in the same finish and smoked glass. **Zip wall units** in basalto finish. Door opening systems: lift-up on wall units and pull-down on base units.

L7

A
sistema Cover in finitura sabbia con **mensole Elle** in finitura frassino juta, **pensili apertura a rialza** con ante vetro fumè e in finitura frassino juta, maniglie A47 in finitura brunito.
Basi a terra con top, cassetti e maniglie A28 in finitura nuvola e con **tavolo estraibile** in finitura olmo tabacco.

Cover system in sabbia finish with **Elle shelves** in frassino juta finish, **wall units with lift-up doors** in smoked glass and frassino juta finish, A47 handles in bronze finish.
Floorstanding base units with top, drawers and A28 handles in nuvola finish and with **pull-out table** in olmo tabacco finish.

B
libreria a terra con vani a giorno in finitura frassino juta, **letto con meccanismo ribaltabile** nella medesima finitura, con **mensola** in finitura olmo tabacco e **divano** in tessuto Maia TM10 con fettuccia a contrasto in finitura grafite.

floorstanding bookcase with open shelving in frassino juta finish, **bed with drop-down mechanism** in the same finish, with **shelf** in olmo tabacco finish and **sofa** in Maia TM10 fabric with contrasting graphite-coloured piping.

C
armadio ante Liscia battenti e **modulo angolo esterno** in finitura sabbia. Maniglie A28 in finitura basalto.

wardrobe with hinged Plain doors and **outside corner module** in sabbia finish. A28 handles in basalto finish.

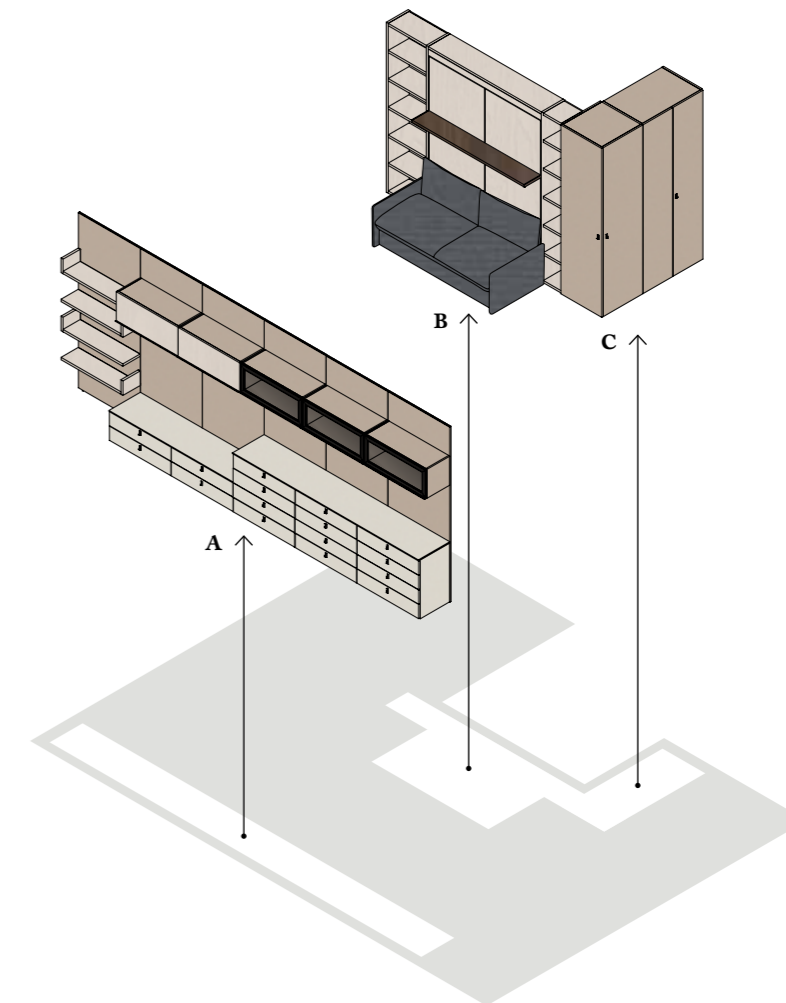

A

sistema Cover,
mensole Elle, pensili,
basi a terra con top

—
Cover system, Elle shelves,
wall units, floorstanding base
units with top

L—W 540 cm
H 221,3 cm
P—D 49,1 cm







B

libreria a terra,
letto con meccanismo
ribaltabile
con mensola
e divano

—
floorstanding
bookcase, bed
with drop-down
mechanism with
shelf and sofa

L—W 262,6 cm
H 221,3 cm
P—D 111,8 | 206 cm

C

armadio ante
battenti e
modulo angolo
esterno
—
hinged door
wardrobe and
outside corner
module

L—W 154 cm
H 221,3 cm
P—D 61,5 cm





stanze intime e confortevoli

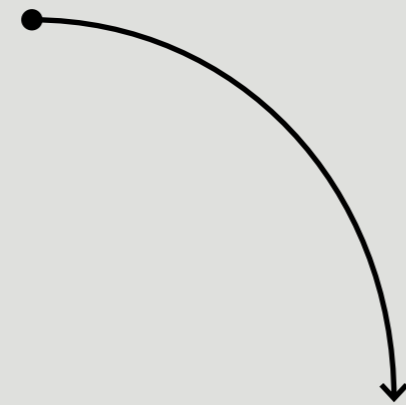

immaginate

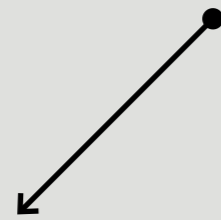

per rispecchiare

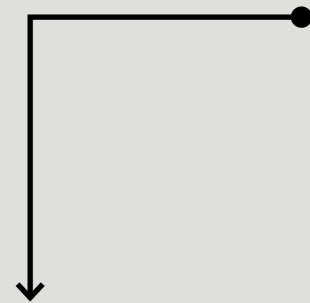

le diverse personalità

intimate, comfortable
rooms conceived to reflect
various personalities.

B1



p. 76

B2



p. 86

B3



p. 96

B4



p. 106

B5



p. 116

B6



p. 126

B7



p. 136

B8



p. 146

B9



p. 156

BI

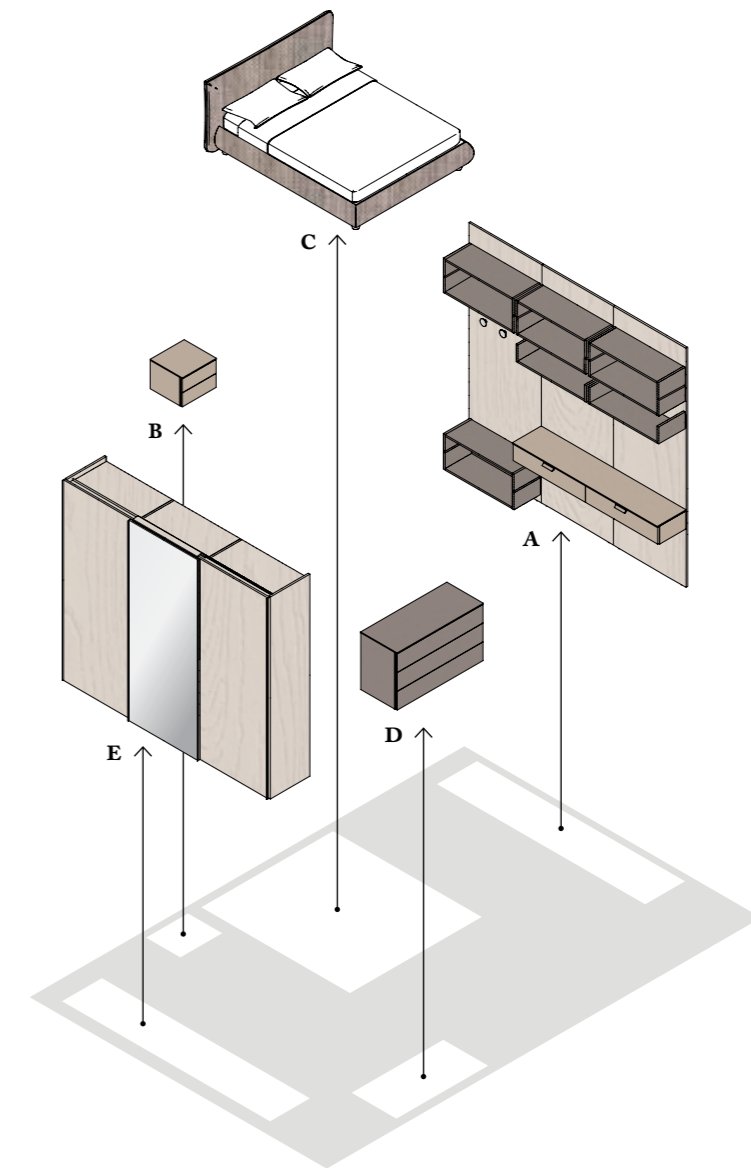
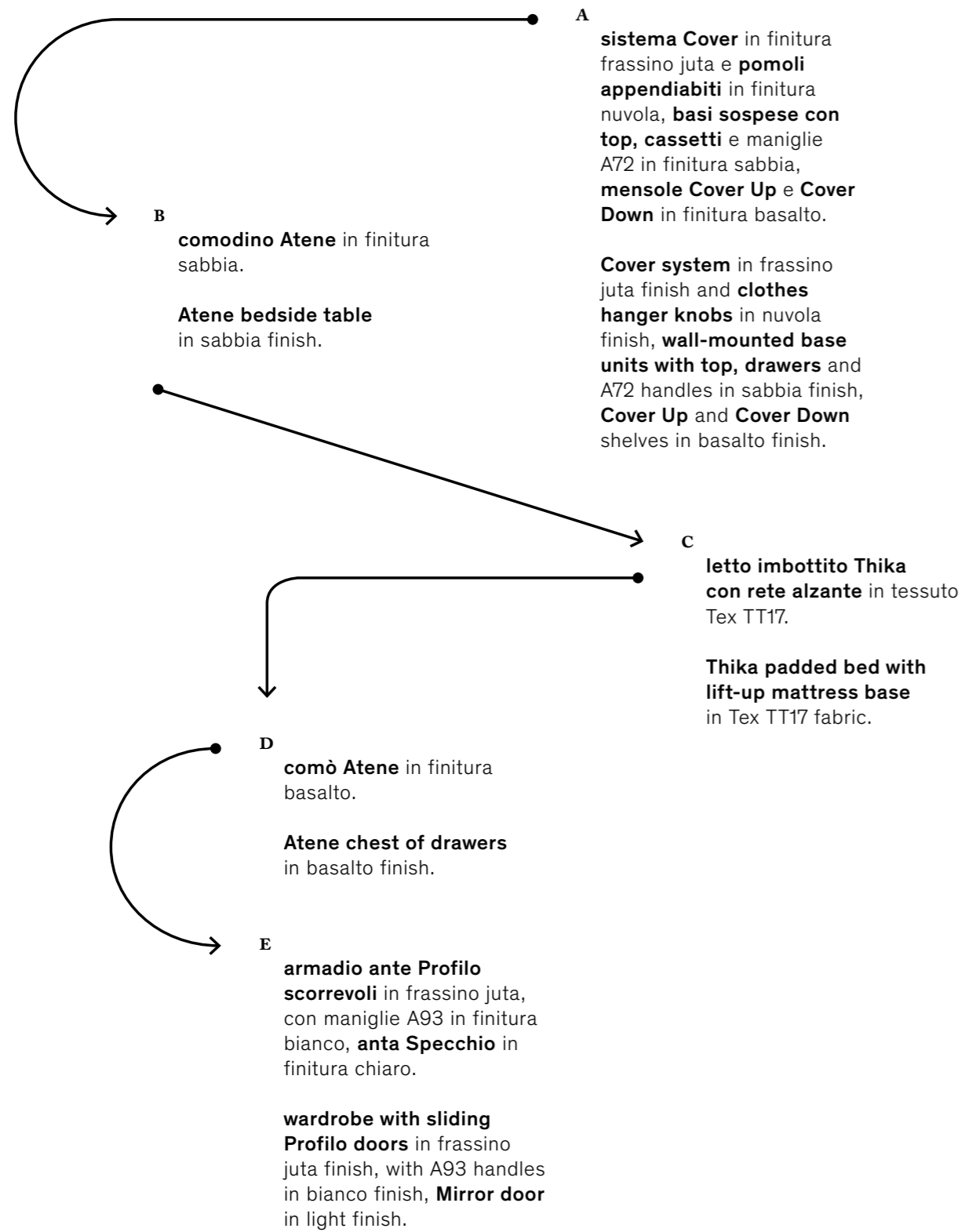

A

sistema Cover, basi
sospese con top,
pomoli appendiabiti
e mensole Cover
Up e Cover Down

—
Cover system,
wall-mounted base
units with top,
clothes hanger
knobs and Cover
Up and Cover Down
shelves

L—W 270 cm
H 257,9 cm
P—D 39,1 cm



B

comodino Atene
—
Atene bedside table

L—W 51 cm
H 39,3 cm
P—D 48,2 cm



C

letto
imbottito Thika
—
Thika
padded bed

L—W 188 cm
H 94 cm
P—D 228 cm





E — KEY PRODUCT

**armadio ante
scorrevoli
—
sliding door
wardrobe**

L—W 302,5 cm
H 257,9 cm
P—D 64,2 cm

D

**comò Atene
—
Atene chest
of drawers**

L—W 128,7 cm
H 75,9 cm
P—D 54,6 cm

KEY PRODUCT

BI.1



Armadio ante Cornice scorrevoli in finitura frassino juta con traverso e maniglie A93 in finitura brunito, **anta Specchio** in finitura brunito.

Wardrobe with sliding Cornice doors in frassino juta finish with crosspiece and A93 handles in bronze finish, and tinted **Mirror door**.

BI.2

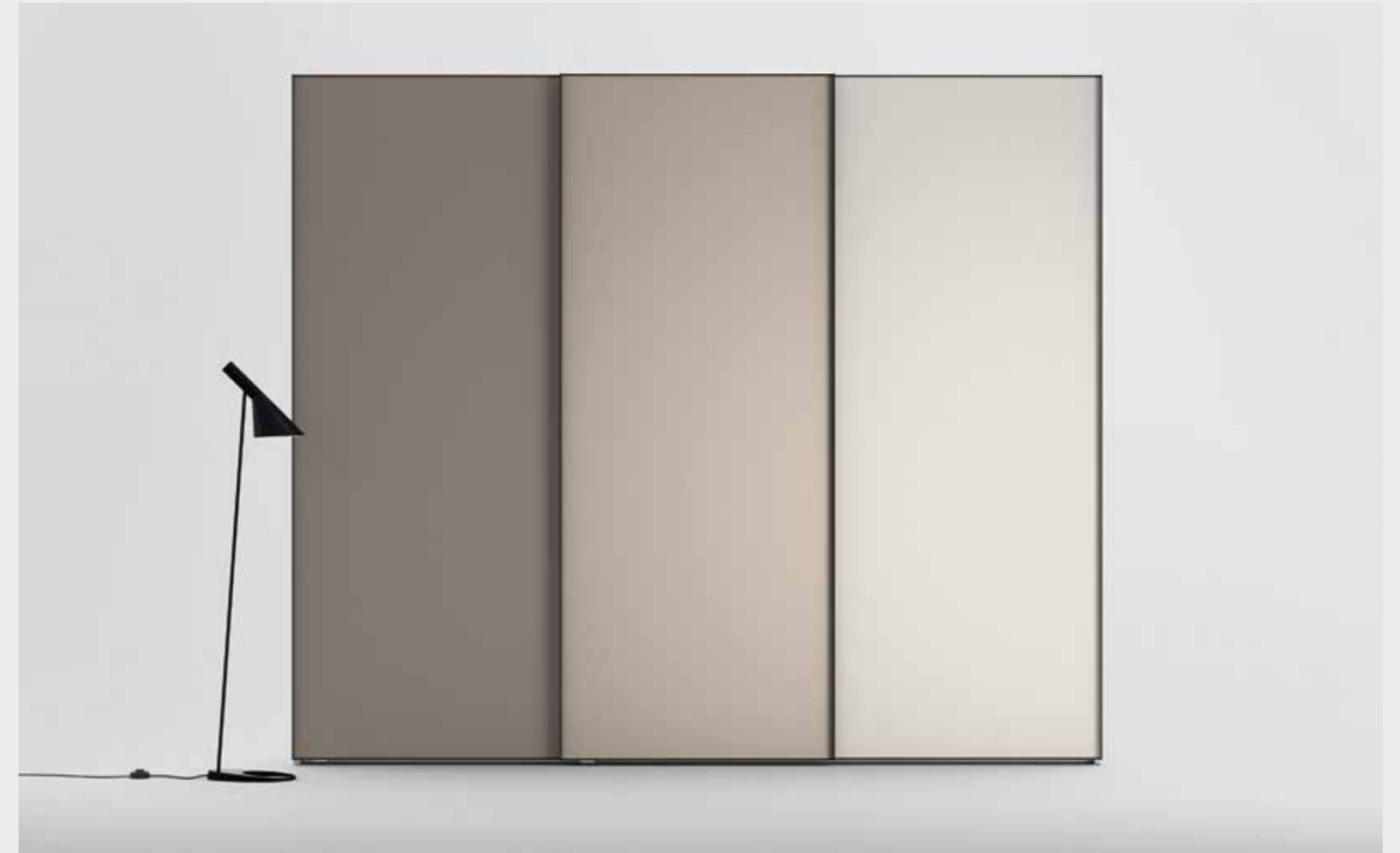

Armadio ante Cornice scorrevoli in finitura basalto, sabbia e nuvola. Maniglie A93 in finitura brunito.

Wardrobe with sliding Cornice doors in basalto, sabbia and nuvola finishes. A93 handles in bronze finish.

B2

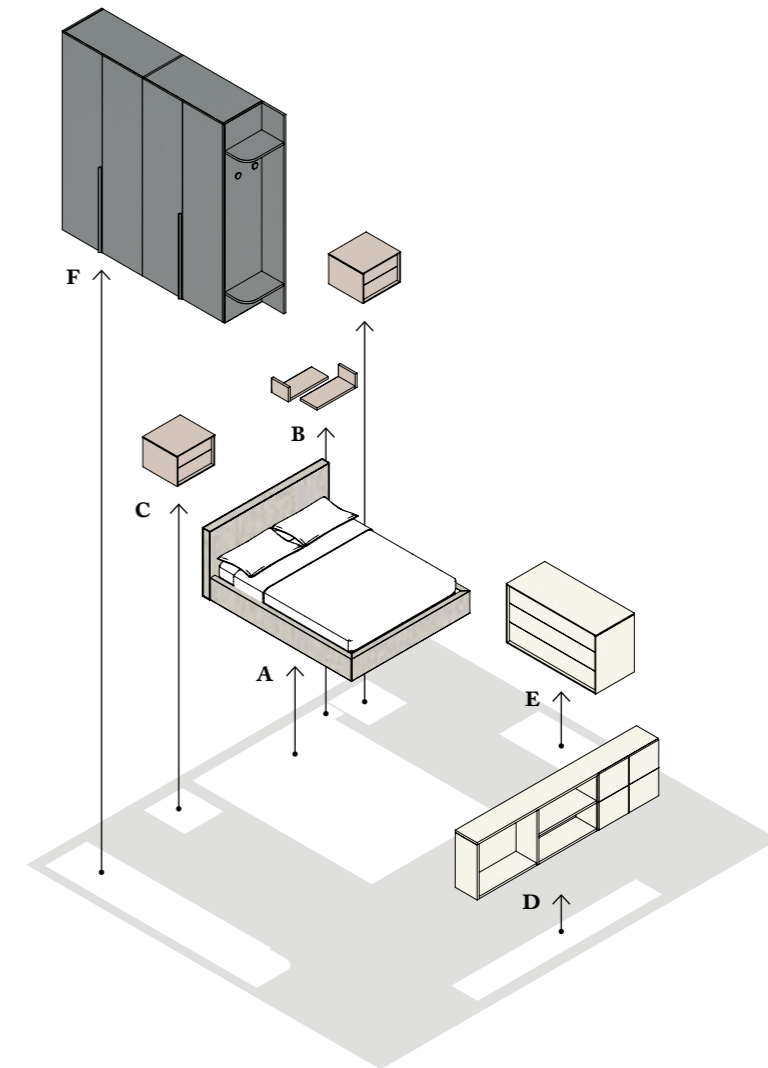
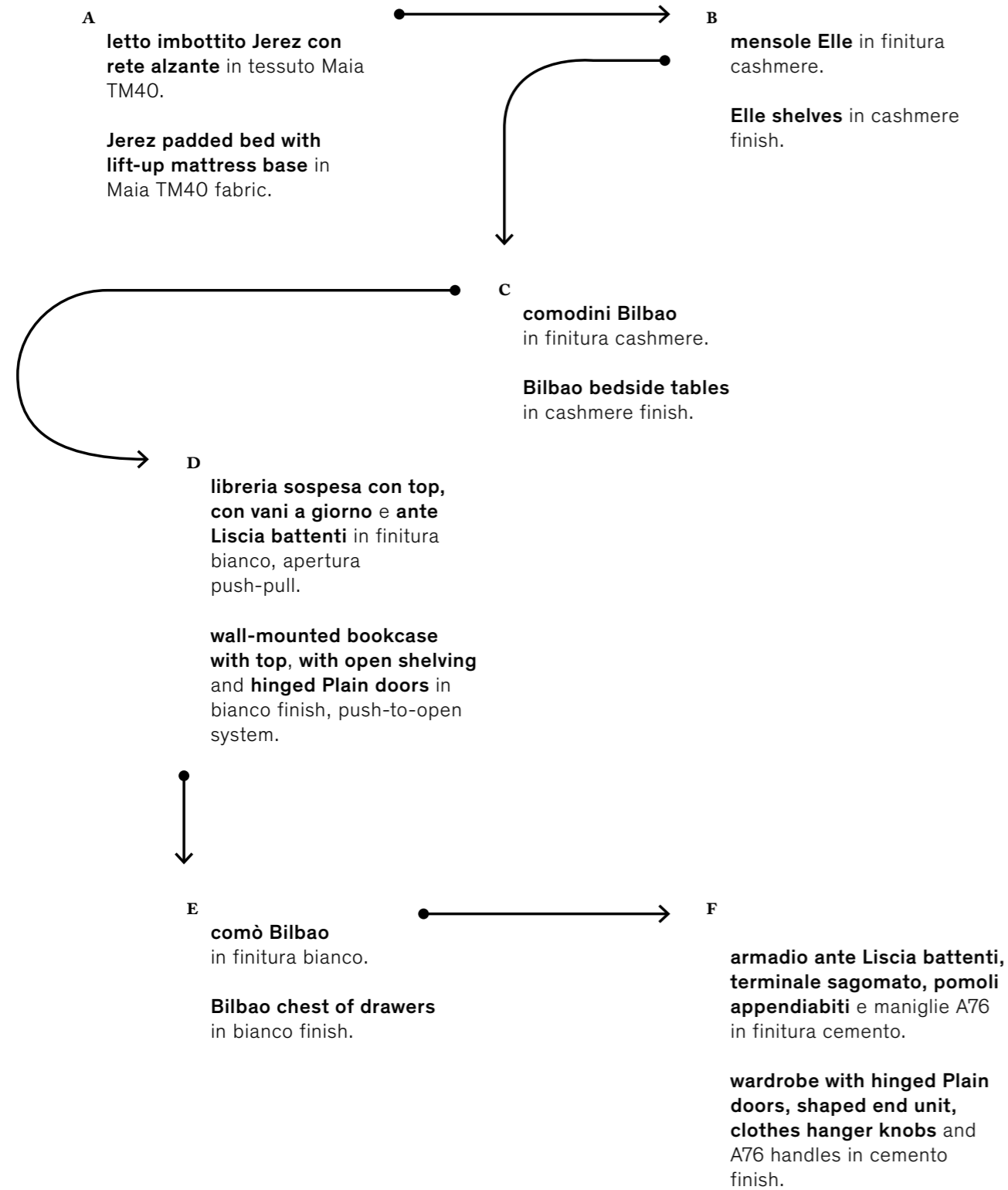



A

letto
imbottito Jerez
—
Jerez
padded bed

L—W 180 cm
H 91 cm
P—D 223 cm

B

mensole Elle
—
Elle shelves

L—W 60 cm
H 18,3 cm
P—D 25,4 cm

C

comodini Bilbao
—
Bilbao bedside
tables

L—W 56,1 cm
H 40,5 cm
P—D 51,4 cm

D

libreria sospesa
con top
—
wall-mounted
bookcase with top

L—W 273 cm
H 74,2 cm
P—D 35,4 cm

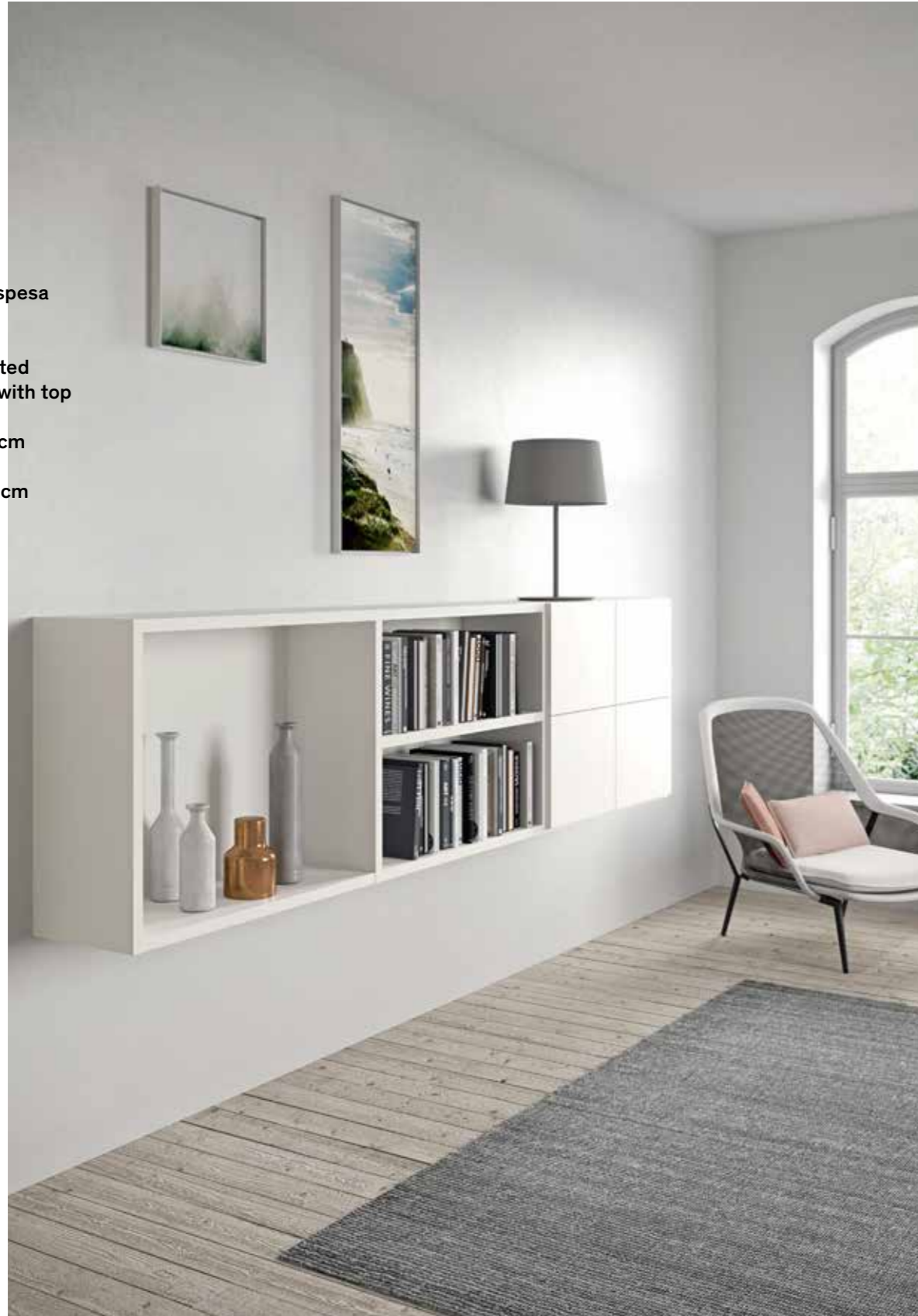

E

comò Bilbao
—
Bilbao chest
of drawers

L—W 134,3 cm
H 77,1 cm
P—D 57,8 cm



F — KEY PRODUCT

**armadio
ante battenti
e terminale
sagomato**

—

**hinged door
wardrobe
and shaped
end unit**

L—W 275,5 cm
H 257,9 cm
P—D 60,6 cm



KEY PRODUCT

B2.1



Armadio ante Liscia battenti in finitura frassino perla con maniglie A67 in finitura bianco, **terminale sagomato** in finitura basalto.

Wardrobe with hinged Plain doors in frassino perla finish with A67 handles in bianco finish, **shaped end unit** in basalto finish.

B2.2



Armadio ante Liscia pieghevoli e maniglie A54 in finitura cashmere, **terminale libreria** in finitura frassino perla.

Wardrobe with folding Plain doors and A54 handles in cashmere finish, **bookcase end unit** in frassino perla finish.

B3

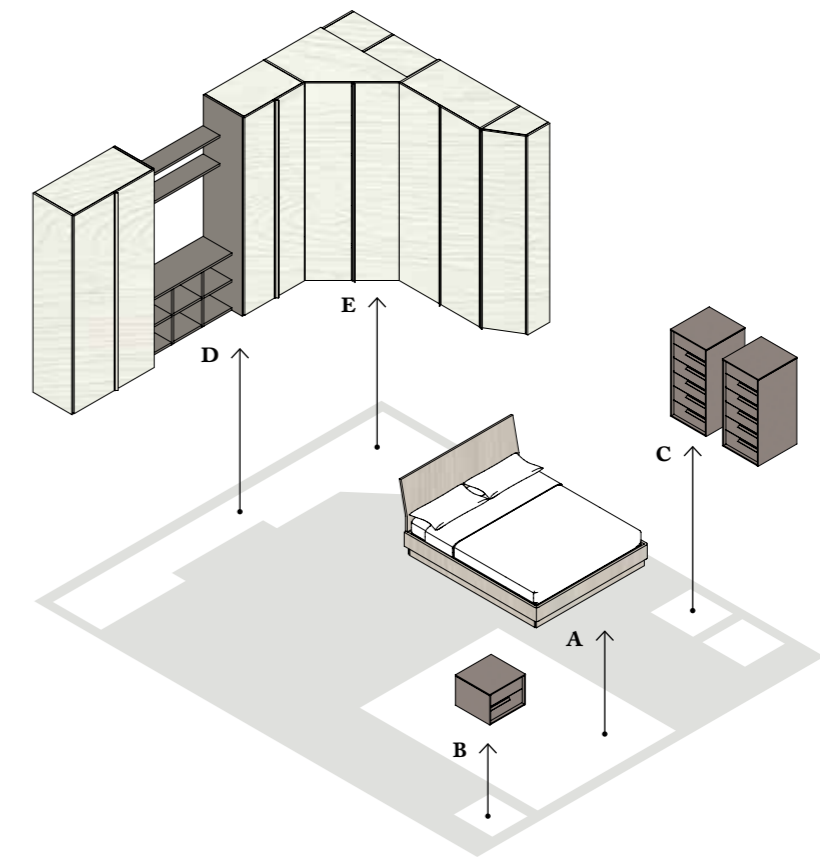
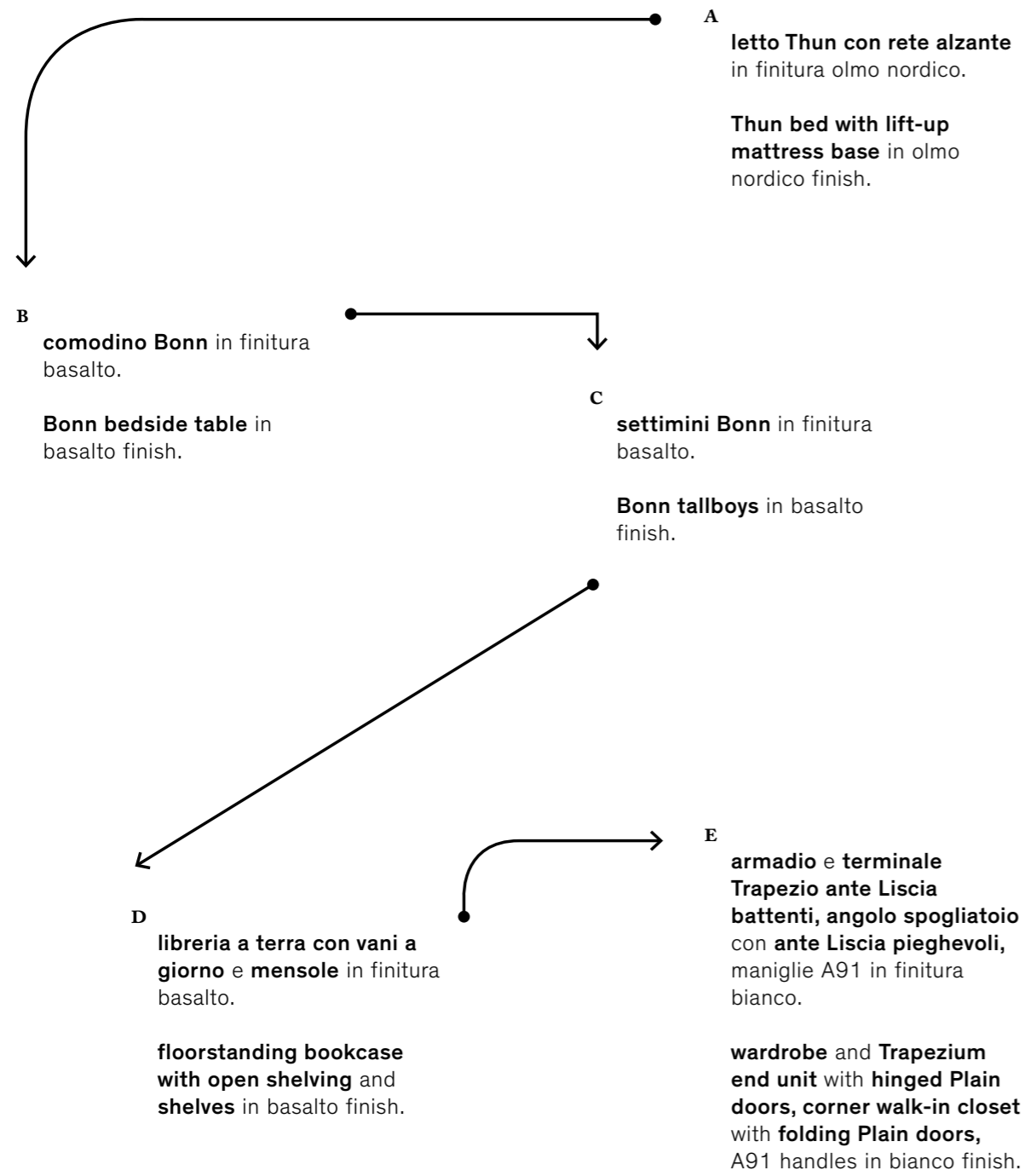



A

letto Thun
—
Thun bed

L—W 168 cm
H 95 cm
P—D 206 cm

B

comodino Bonn
—
Bonn bedside table

L—W 53,3 cm
H 40,5 cm
P—D 51,4 cm

C

settimini
Bonn
—
Bonn
tallboys

L—W 53,7 cm
H 113,7 cm
P—D 57,8 cm



D

libreria a terra
e mensole
—
floorstanding
bookcase
and shelves

L—W 132 cm
H 74,9 cm
P—D 43 cm

L—W 132 cm
H 3 cm
P—D 25 cm



E — KEY PRODUCT

**armadio ante
battenti,
terminale
Trapezio e
angolo
spogliatoio
con ante
pieghevoli**

**—
hinged door
wardrobe,
Trapezium end
unit and corner
walk-in closet
with folding
doors**



KEY PRODUCT

B3.1



Sistema Cover in finitura olmo nordico, **basi sospese con top** e cassetti, maniglie A72 e **mensole Cover Up** e **Cover Down** in finitura basalto.

Cover system in olmo nordico finish, **wall-mounted base units with top** and drawers, A72 handles and **Cover Up** and **Cover Down shelves** in basalto finish.

Composizione ad angolo con **armadio ante Liscia battenti** in finitura olmo nordico, maniglie A76 in finitura basalto, **terminale libreria** con specchio in finitura basalto.

Corner configuration featuring **wardrobe with hinged Plain doors** in olmo nordico finish, A76 handles in basalto finish, **bookcase end unit** with mirror in basalto finish.

B4

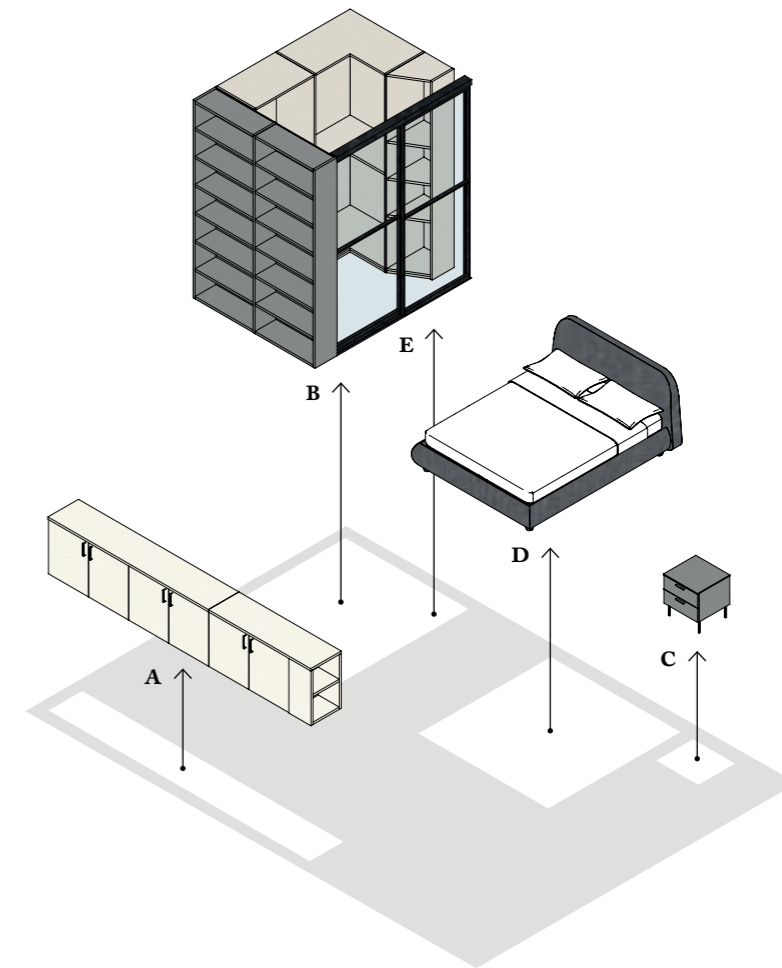
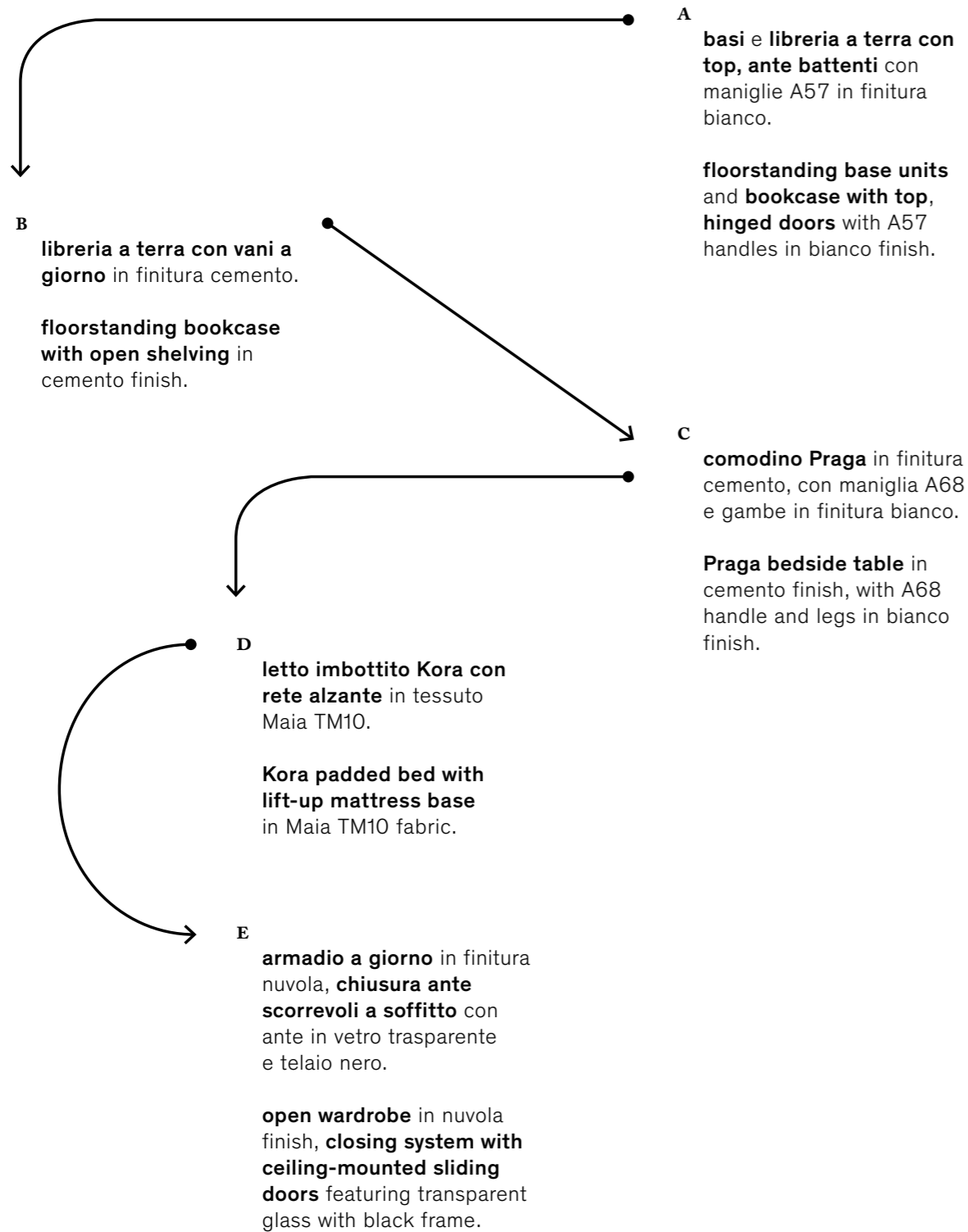

A

basi e libreria a
terra con top
—
floorstanding base
units and bookcase
with top

L—W 393 cm
H 77,9 cm
P—D 45,8 cm



B

libreria
a terra
—
floorstanding
bookcase

L—W 183 cm
H 257,9 cm
P—D 33 cm



C

comodino
Praga
—
Praga
bedside table

L—W 51 cm
H 54,8 cm
P—D 48,2 cm



E — KEY PRODUCT

**armadio a
giorno e
chiusura ante
scorrevoli**
—
**open
wardrobe
and closing
system with
sliding doors**

L—W 202,3 cm
H 257,9 cm
P—D 172,3 cm



D

**letto
imbottito Kora**
—
**Kora
padded bed**

L—W 184 cm
H 97 cm
P—D 226 cm

KEY PRODUCT

B4.1



Chiusura ante Liscia battenti e pieghevoli con maniglie A96 in finitura bianco, **libreria a terra** con vani a giorno in finitura olmo nordico. **Cabina a spalla** in finitura nuvola.

Closing system with hinged and folding Plain doors with A96 handles in bianco finish, **floorstanding bookcase** with open shelving in olmo nordico finish. **Walk-in closet system with load-bearing side panels** in nuvola finish.



B5

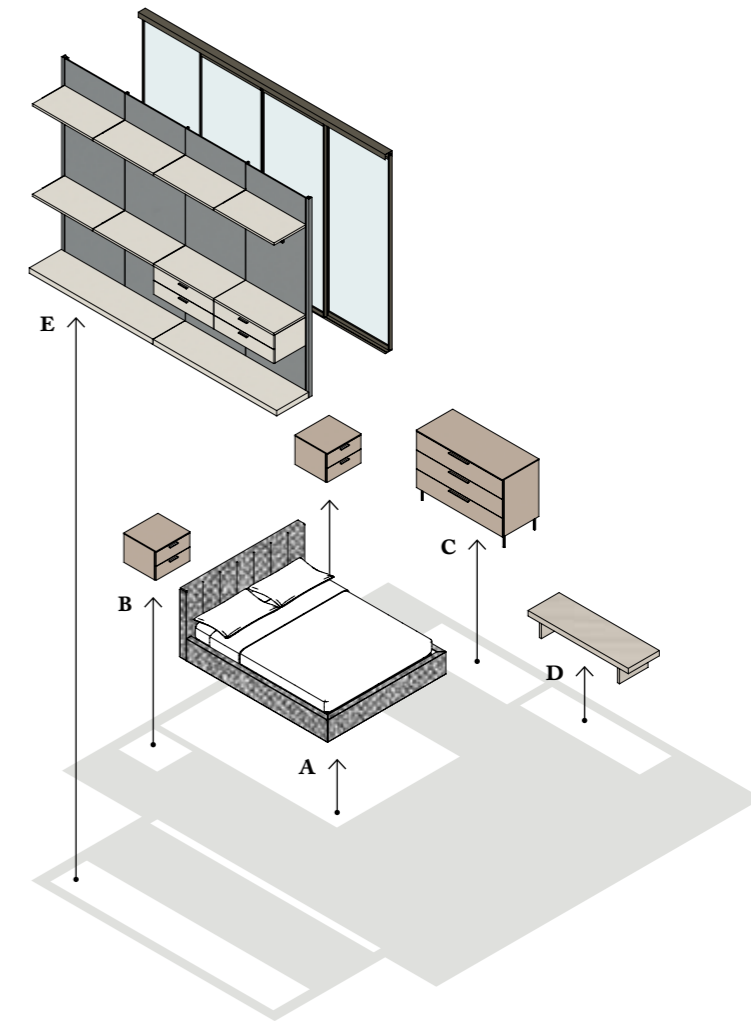
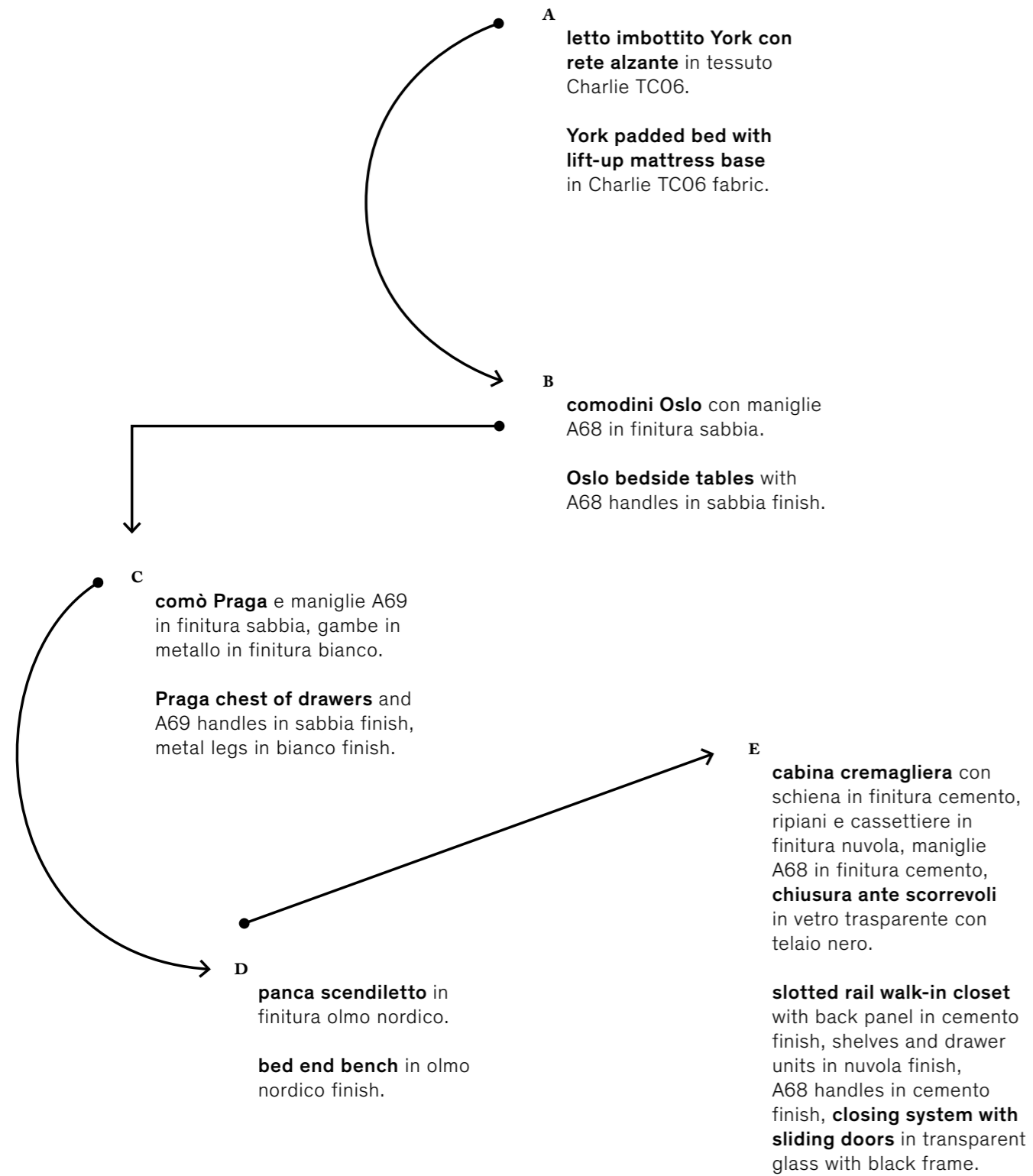



A

letto
imbottito York
—
York
padded bed

L—W 178 cm
H 92 cm
P—D 222 cm

B

comodini Oslo
—
Oslo
bedside tables

L—W 51 cm
H 39,3 cm
P—D 48,2 cm

C

comò Praga
—
Praga chest
of drawers

L—W 128,7 cm
H 91,4 cm
P—D 54,6 cm





D

panca
scendiletto
—
bed end bench

L—W 150 cm
H 29 cm
P—D 46,8 cm



E — KEY PRODUCT

**cabina
cremagliera
—
slotted rail
walk-in
closet**

L—W 369,5 cm
H 257,9 cm
P—D 50,8 cm



KEY PRODUCT

B5.1



Cabina cremagliera con ripiani, cassettiere e pedana in finitura olmo nordico, maniglie A72 in finitura nuvola.

Slotted rail walk-in closet with shelves, drawer units and plinth in olmo nordico finish, A72 handles in nuvola finish.

B5.2



Cabina cremagliera con pedana in finitura cashmere, cassettiere e ripiani in finitura olmo tabacco, maniglie A52 nella medesima finitura.

Slotted rail walk-in closet with plinth in cashmere finish, drawer unit and shelves in olmo tabacco finish, A52 handles in the same finish.

B6

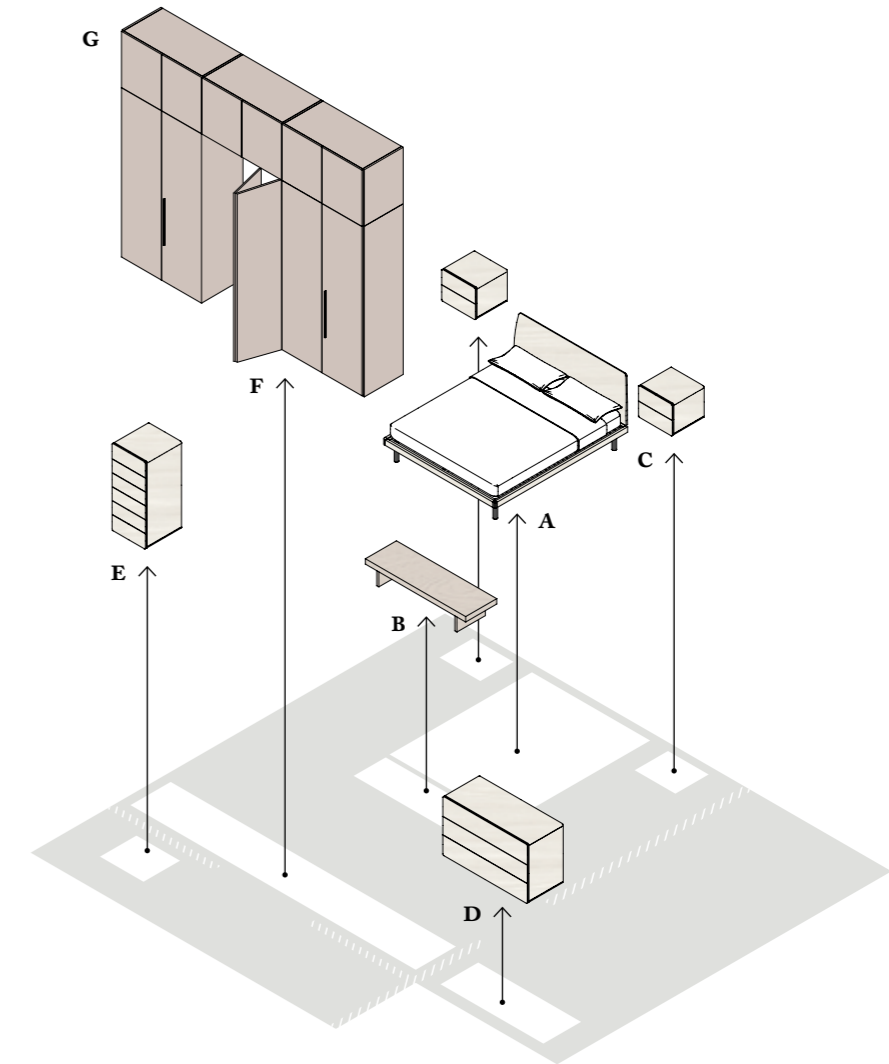
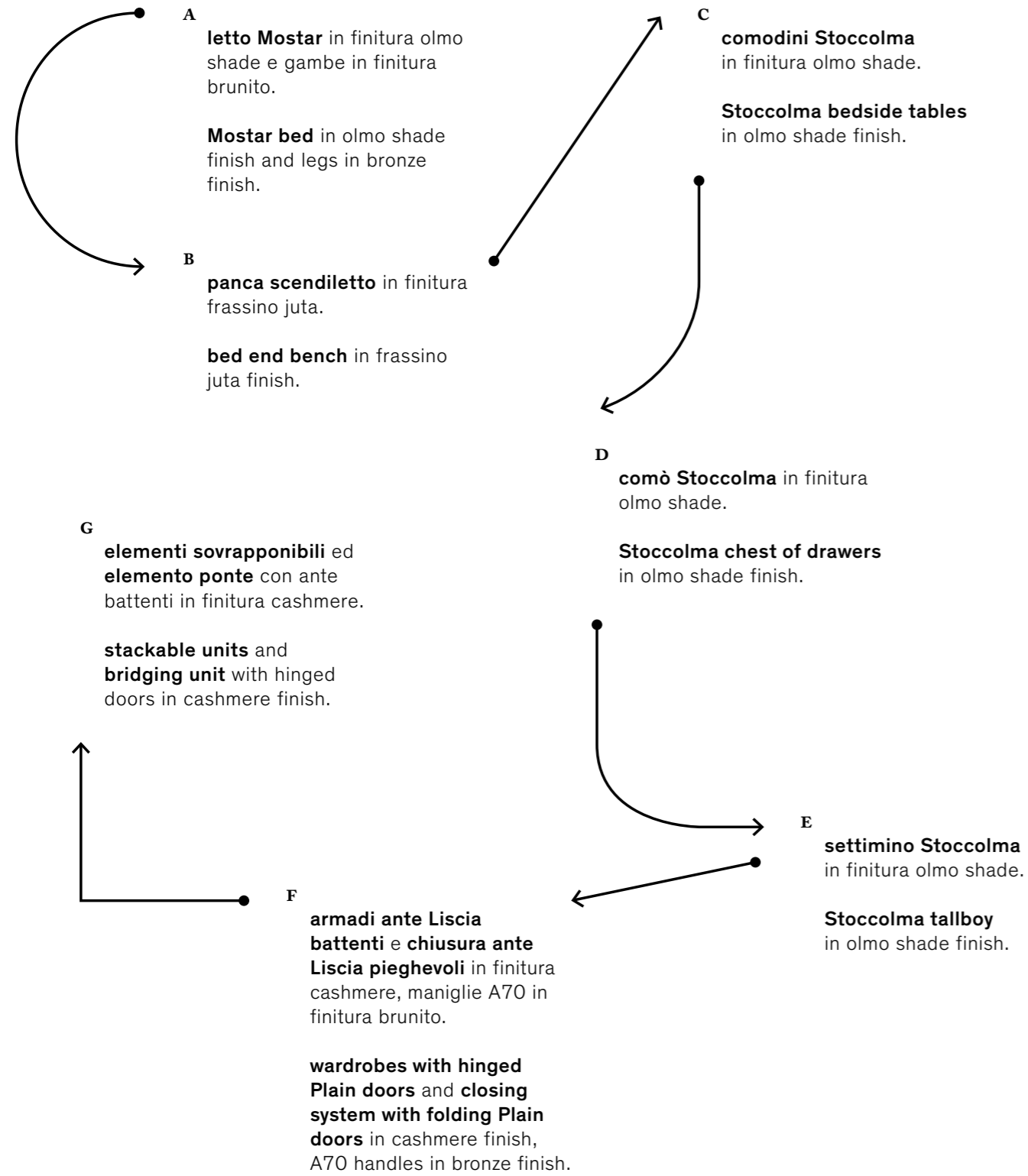



A, B

letto Mostar
e panca scendiletto
—
Mostar bed and
bed end bench

L—W 168 cm
H 97 cm
P—D 206 cm

L—W 150 cm
H 29 cm
P—D 46,8 cm

C

comodini
Stoccolma
—
Stoccolma
bedside tables

L—W 51 cm
H 42,5 cm
P—D 48,2 cm





D

comò Stoccolma
—
Stoccolma
chest of drawers

L—W 128,7 cm
H 80,1 cm
P—D 54,6 cm



E

settimino
Stoccolma
—
Stoccolma
tallboy

L—W 51 cm
H 115,7 cm
P—D 54,6 cm

F, G — KEY PRODUCT

**composizione con
armadi, elemento
ponte ed elementi
sovrapponibili con
ante battenti,
chiusura
pieghevole**

**—
configuration
with wardrobes,
bridging unit and
stackable units
with hinged doors,
folding closing
system**

L—W 362,5 cm
H 221,3 cm
P—D 60,6 cm

L—W 362,5 cm
H 73,2 cm
P—D 60,6 cm



KEY PRODUCT

B6.1



Armadio ante Liscia battenti, con cassetti e cassettone, **elementi sovrapponibili** ed **elemento ponte** in finitura olmo nordico. Maniglie A63 e A57 in finitura bianco. **Chiusura con ante Specchio pieghevoli** in finitura chiaro e maniglie A93 in finitura bianco.

Wardrobe with hinged Plain doors, with regular and oversized drawers, **stackable units** and **bridging unit** in olmo nordico finish. A63 and A57 handles in bianco finish. **Closing system with folding Mirror doors** in light finish and A93 handles in bianco finish.

B6.2



Armadio con ante stagionali, elemento **sovrapponibile**, **elemento ponte** e **chiusura con ante Liscia battenti** in finitura sabbia. Maniglie A69 e A70 in finitura brunito.

Wardrobe with centre-split doors, **stackable unit**, **bridging unit** and **closing system with hinged Plain doors** in sabbia finish. A69 and A70 handles in bronze finish.

B7

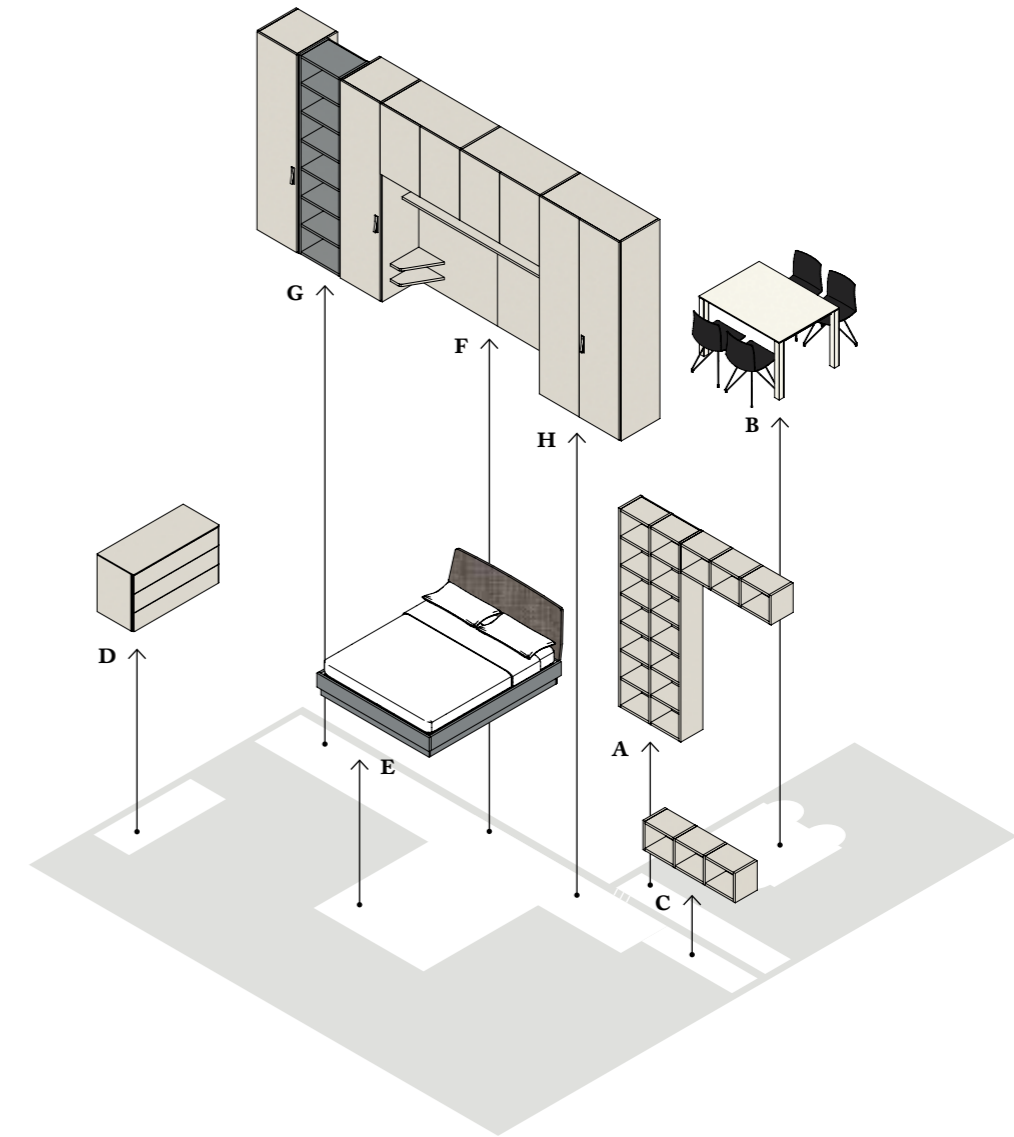
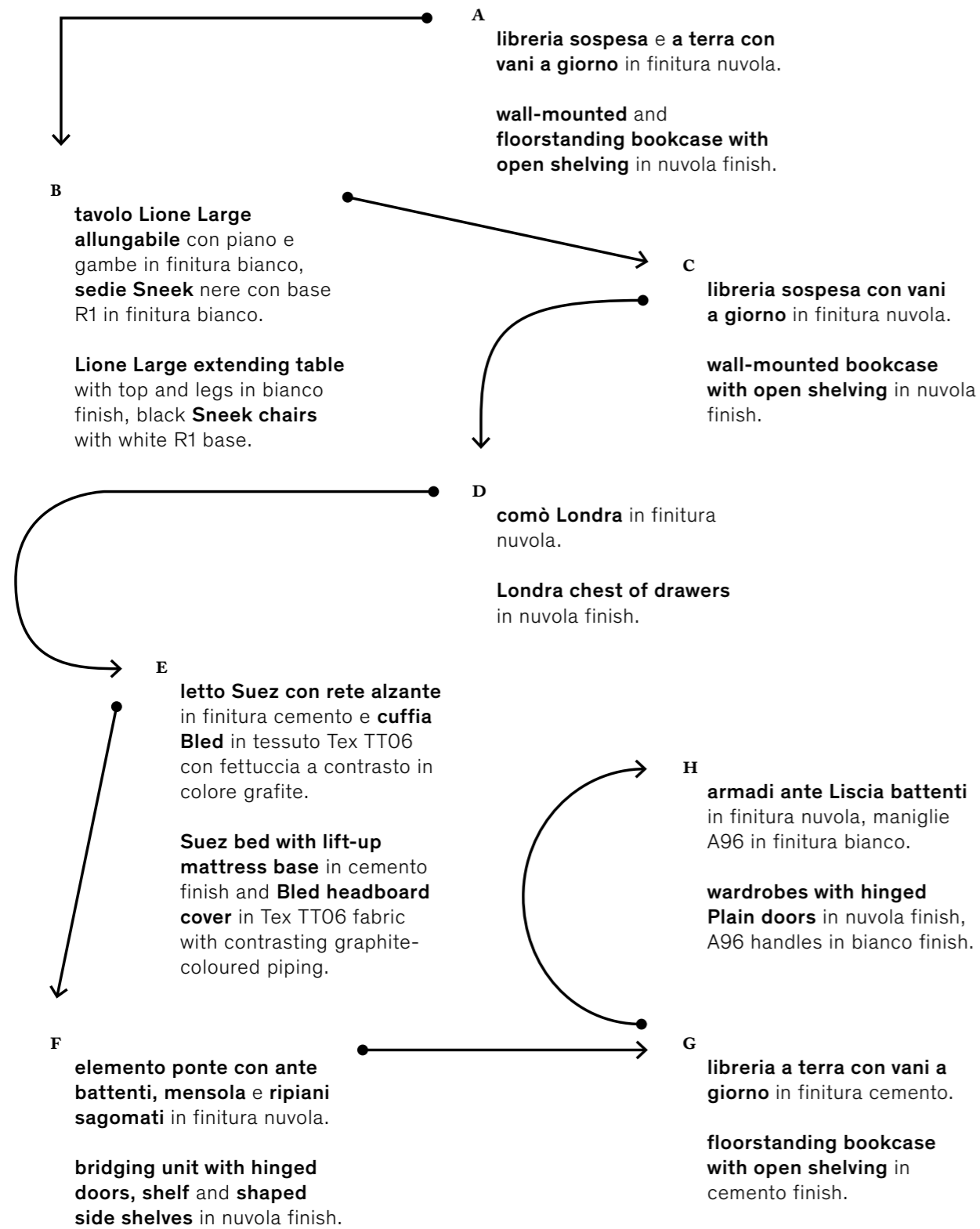

A

libreria
sospesa e a terra
—
wall-mounted
and freestanding
bookcase

L—W 228 cm
H 257,9 cm
P—D 33 cm



B

tavolo Leone
e sedie Sneek
—
Lione table and
Sneek chairs

L—W 120/220 cm
H 75,6 cm
P—D 90 cm



C
**libreria
 sospesa**
 —
**wall-mounted
 bookcase**

L—W 138 cm
 H 38,1 cm
 P—D 33 cm



D
comò Londra
 —
**Londra chest
 of drawers**

L—W 128,9 cm
 H 75,9 cm
 P—D 54,6 cm

F, G, H — KEY PRODUCT

**composizione
con armadi ed
elemento ponte
con ante battenti,
libreria a terra**

—
**configuration
with wardrobes,
bridging unit with
hinged doors,
floorstanding
bookcase**

L—W 548 cm
H 257,9 cm
P—D 60,6 cm



E

**letto Suez
con cuffia Bled**
—
**Suez bed with Bled
headboard cover**

L—W 175 cm
H 90 cm
P—D 206 cm

KEY PRODUCT

B7.1



Armadio ante Liscia battenti in finitura basalto con maniglie A67 in finitura brunito, **libreria a ponte** con vani a giorno in finitura basalto e schiena in olmo nordico. **Letto Este** con rete alzante e **meccanismo Pratic** in finitura lavagna.

Wardrobe with hinged Plain doors in basalto finish with A67 handles in bronze finish, **bridging bookcase** with open shelving in basalto finish and back panel in olmo nordico. **Este bed** with lift-up mattress base and **Pratic mechanism** in lavagna finish.



B7.2



Armadio ante Gola battenti e libreria a terra in finitura cashmere con schiena in finitura olmo tabacco. **Letto con meccanismo ribaltabile** in finitura cashmere con schiena in finitura olmo tabacco e cashmere, maniglie A52 in finitura olmo tabacco.

Wardrobe with hinged Gola doors and floorstanding bookcase in cashmere finish with back panel in olmo tabacco finish. **Bed with drop-down mechanism** in cashmere finish with back panel in olmo tabacco and cashmere finishes, A52 handles in olmo tabacco finish.



B8

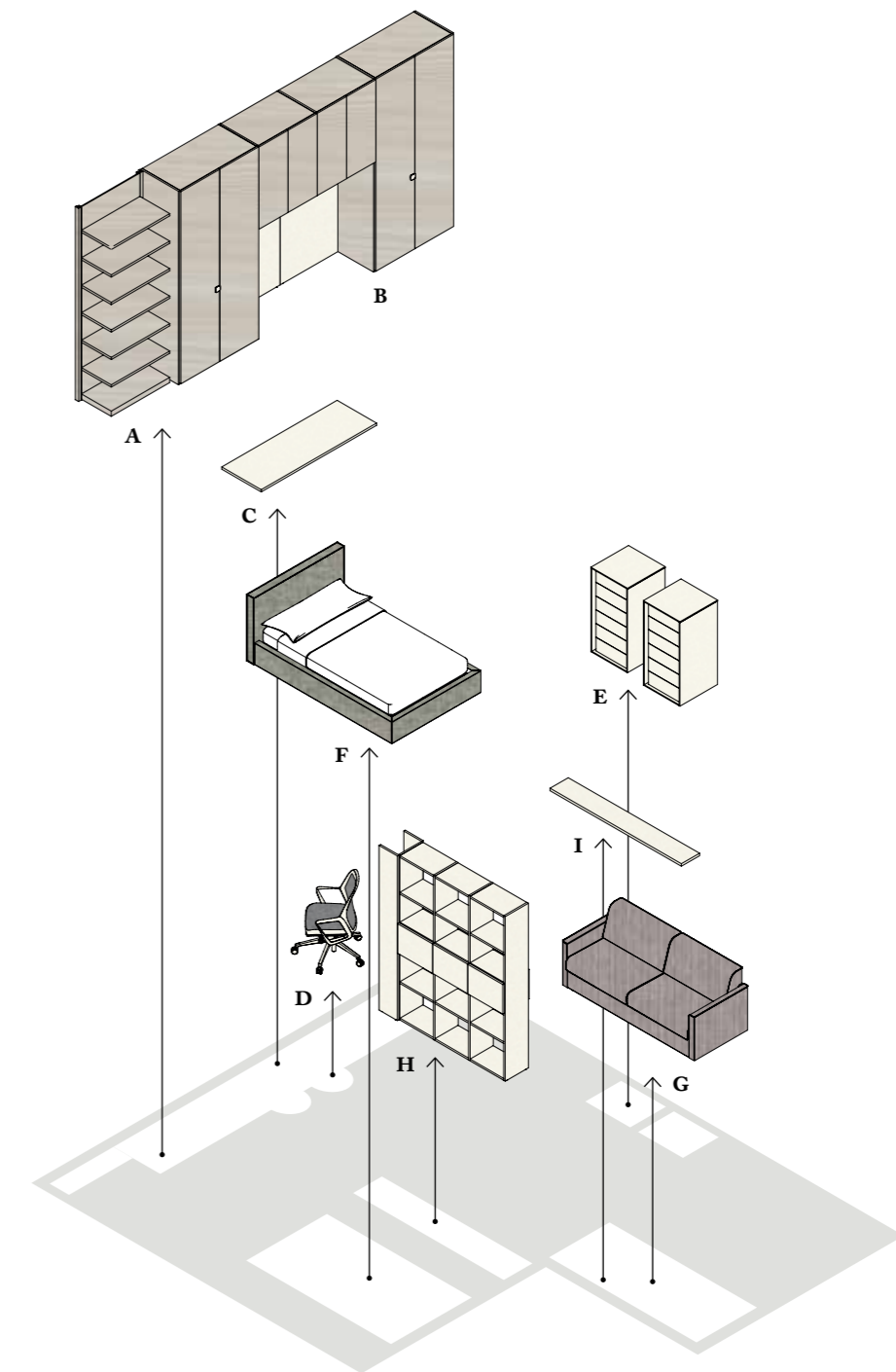
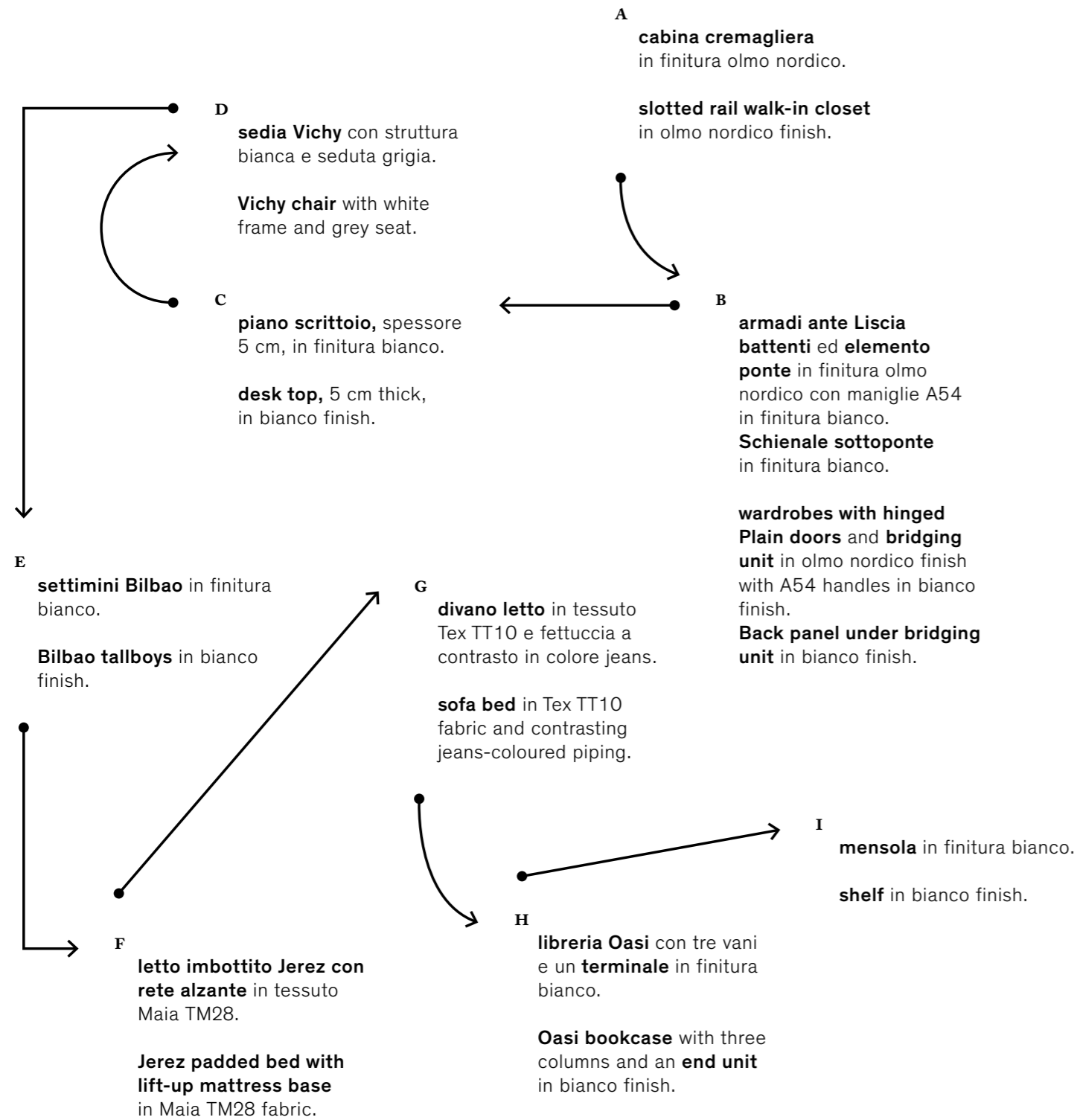

A

**cabina
cremagliera**
—
**slotted rail
walk-in closet**

L—W **98,8 cm**
H **257,9 cm**
P—D **50,8 cm**

B

**armadi ed
elemento ponte
con ante battenti**
—
**wardrobes and bridging
unit with hinged doors**

L—W **422,5 cm**
H **257,9 cm**
P—D **60,6 cm**

C, D

**piano scrittoio e
sedia Vichy**
—
**desk top
and Vichy chair**

L—W **177,5 cm**
H **5 cm**
P—D **54,9 cm**





E
 settimini Bilbao
 —
 Bilbao tallboys
 L—W 56,1 cm
 H 113,7 cm
 P—D 57,8 cm

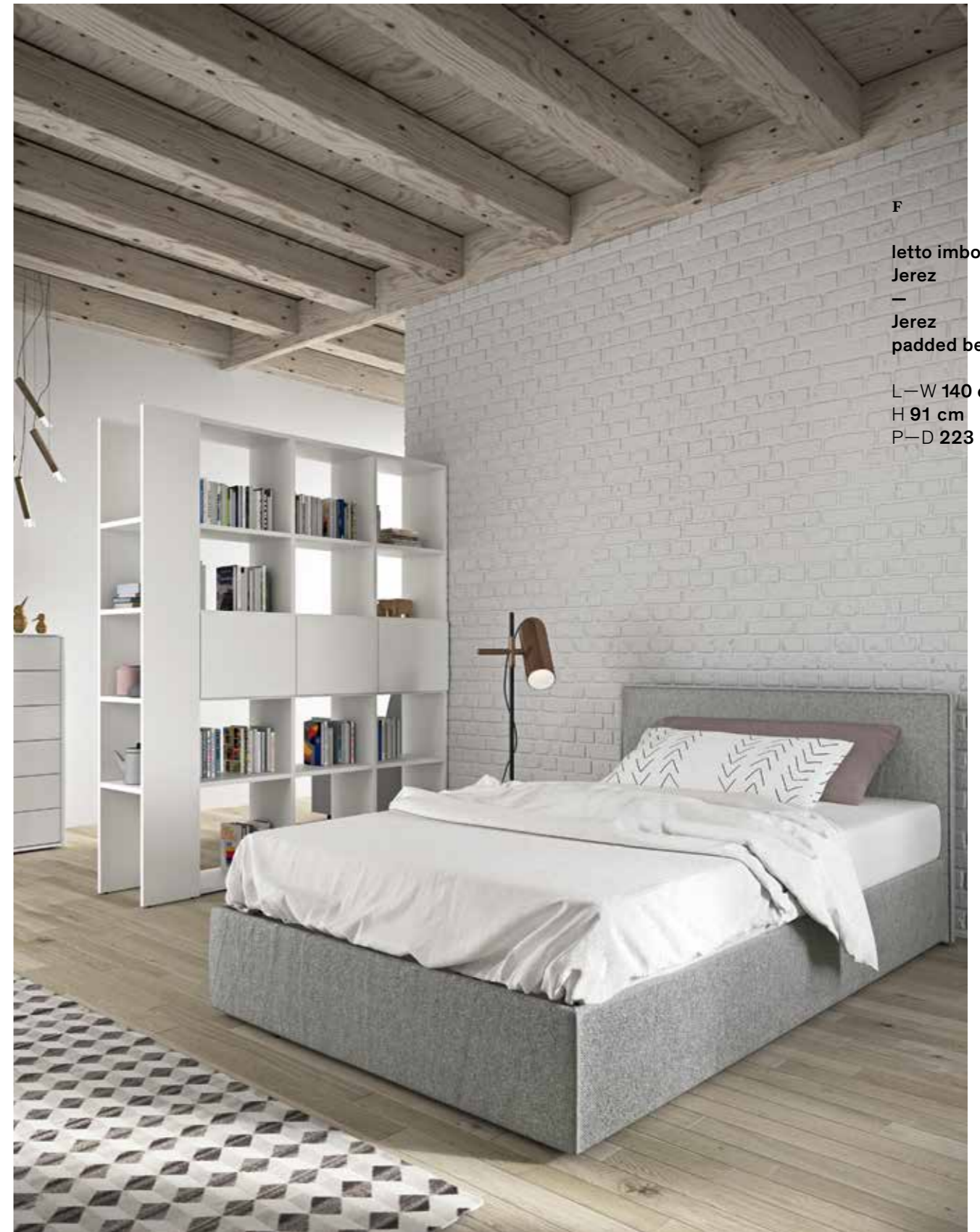

F
 letto imbottito
 Jerez
 —
 Jerez
 padded bed
 L—W 140 cm
 H 91 cm
 P—D 223 cm

I
mensola
 —
shelf
 L—W 180 cm
 H 3 cm
 P—D 25 cm

G
divano letto
 —
sofa bed
 L—W 204 cm
 H 85 cm
 P—D 86/225 cm



H — KEY PRODUCT

libreria Oasi
 —
Oasi
bookcase

L—W 177,8 cm
 H 203 cm
 P—D 37,4 cm



KEY PRODUCT

B8.1



Libreria Oasi con due vani e ante battenti apertura push-pull in finitura nuvola e due **terminali** in finitura basalto.

Oasi bookcase with two columns and push-to-open hinged doors in nuvola finish and two **end units** in basalto finish.

B8.2



Libreria Oasi con due vani in finitura bianco, ante battenti apertura push-pull e **terminale** in finitura olmo nordico.

Oasi bookcase with two columns in bianco finish, push-to-open hinged doors and **end unit** in olmo nordico finish.

B9

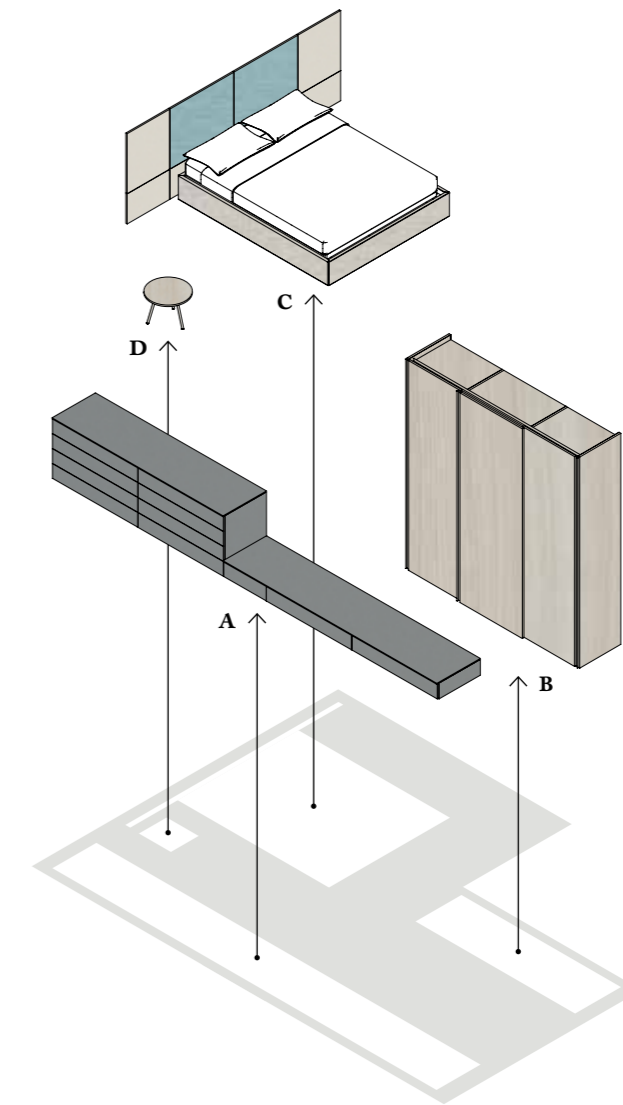
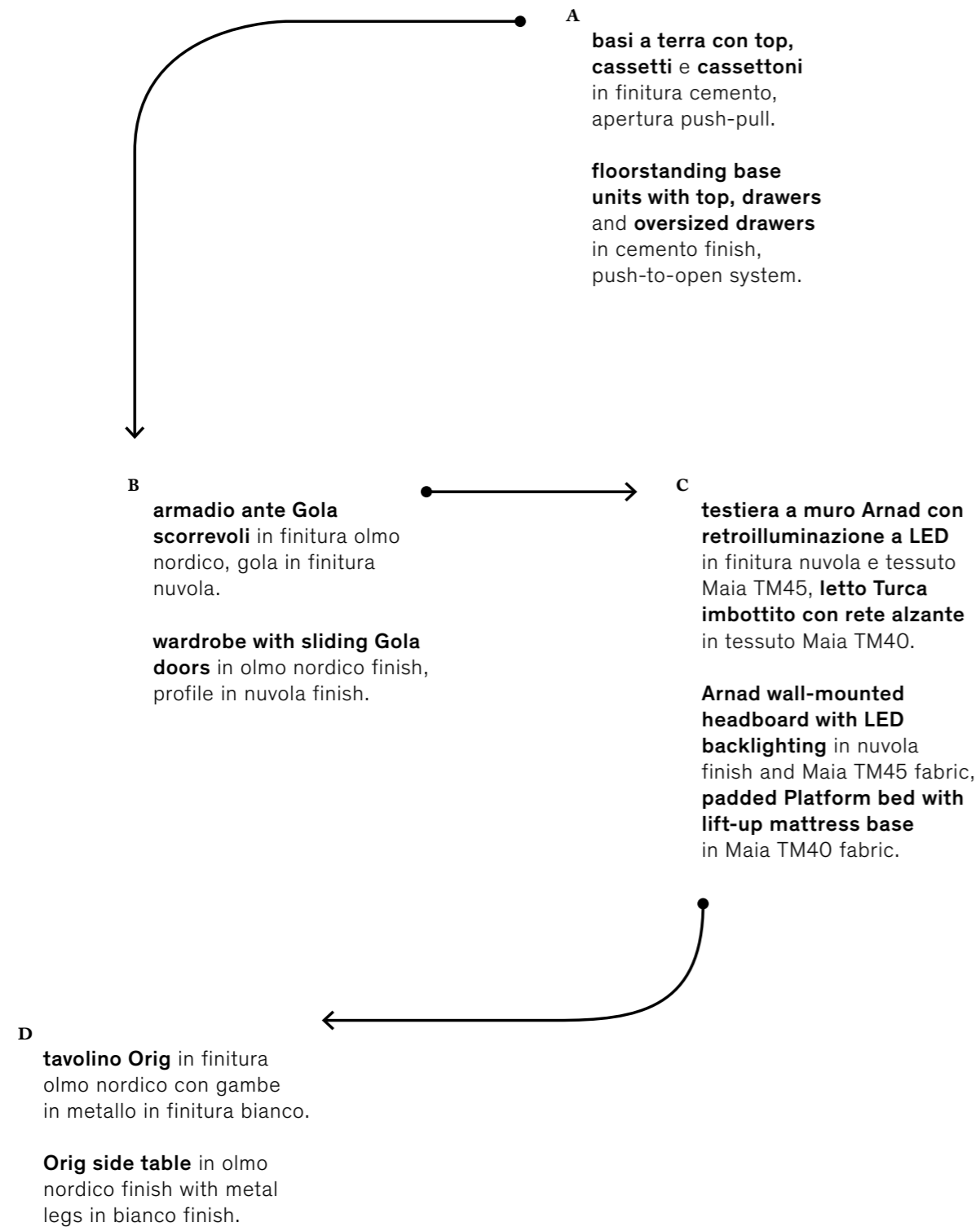



A

basi a terra
con top
—
floorstanding
base units
with top

L—W 540 cm
H 76,1|21,2 cm
P—D 60,6 cm



B

armadio ante
scorrevoli
—
sliding door
wardrobe

L—W 242,5 cm
H 257,9 cm
P—D 64,2 cm

C — KEY PRODUCT

**testiera a
muro Arnad,
letto Turca
imbottito**

—
**Arnad
wall-mounted
headboard,
padded
Platform bed**

L—W 300 cm
H 109,8 cm
P—D 217,5 cm

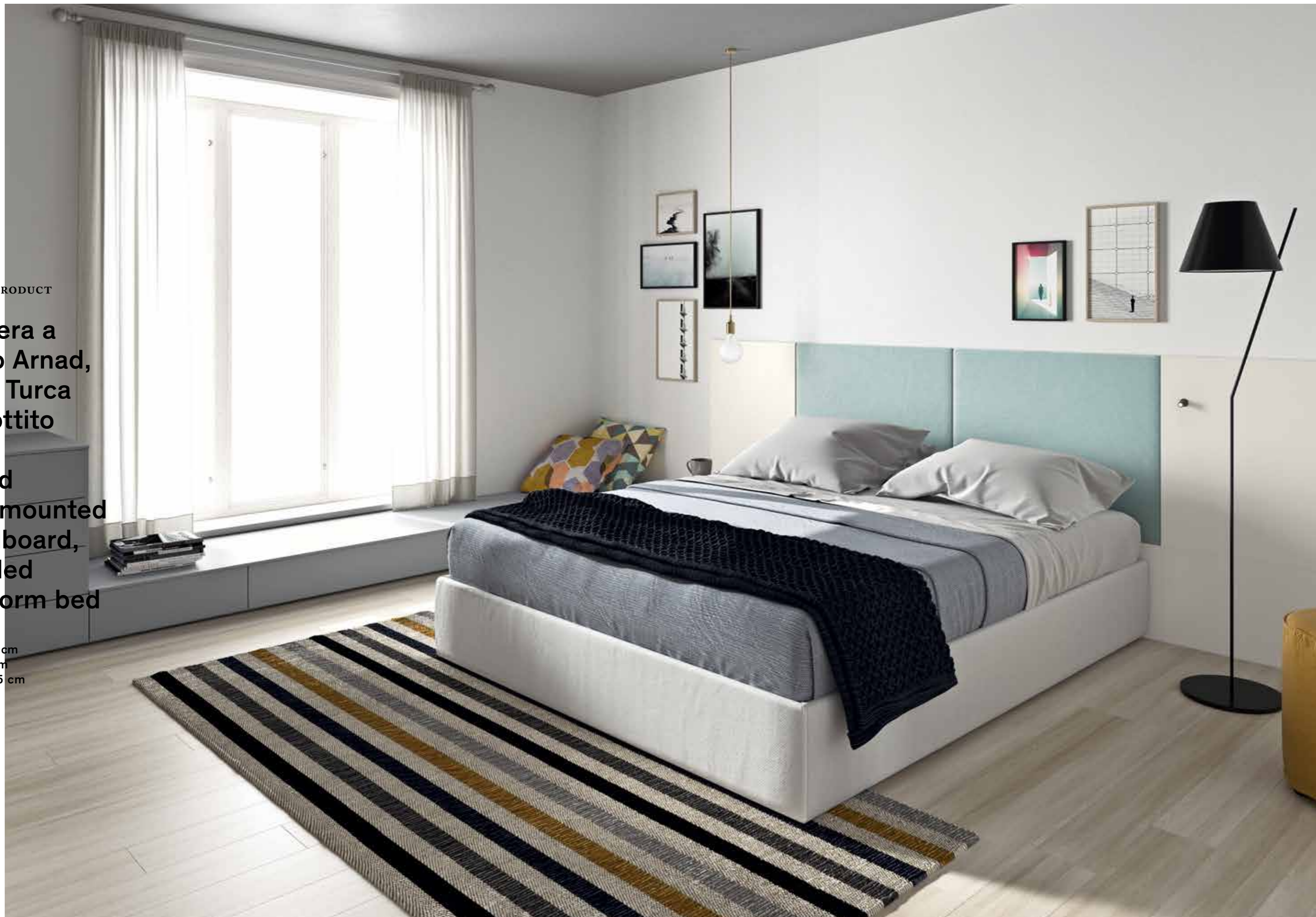



D

tavolino Orig
—
Orig side table

Ø 48 cm
H 34,8 cm

KEY PRODUCT

B9.1



**Testiera a muro
Arnad** in finitura
olmo tabacco e
in tessuto Charlie
TC12 e TC39, con
giroletto R120 con
gambe in finitura
olmo tabacco.

**Arnad
wall-mounted
headboard** in olmo
tabacco finish and
Charlie TC12 and
TC39 fabrics, with
R120 bed surround
with legs in olmo
tabacco finish.

B9.2



**Testiera a muro
Arnad** in finitura
olmo shade e
in tessuto Maia
TM23 e TM42 con
giroletto R180
stondato in finitura
nuvola.

**Arnad
wall-mounted
headboard** in olmo
shade finish and
Maia TM23 and
TM42 fabrics with
rounded R180 bed
surround in nuvola
finish.

**ambienti
domestici**

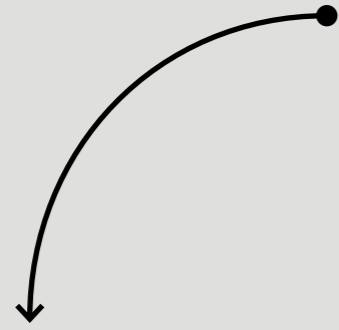

multifunzionali

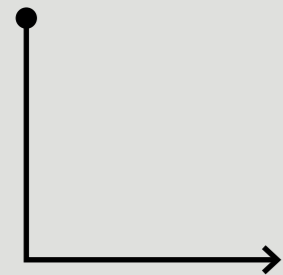

**organizzati
per garantire**

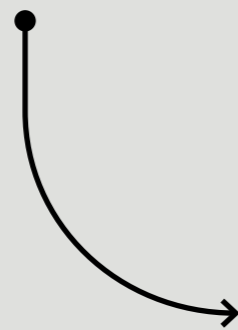

**praticità
e ordine**

multifunctional
home interiors
organized to ensure
practicality and order.

U1



p. 166

U2



p. 172

U3



p. 180

U4



p. 188

U5



p. 196

U6



p. 204

UI

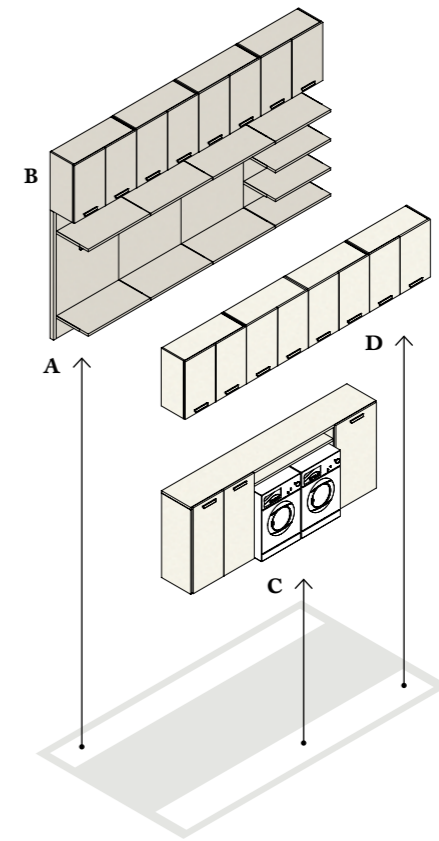
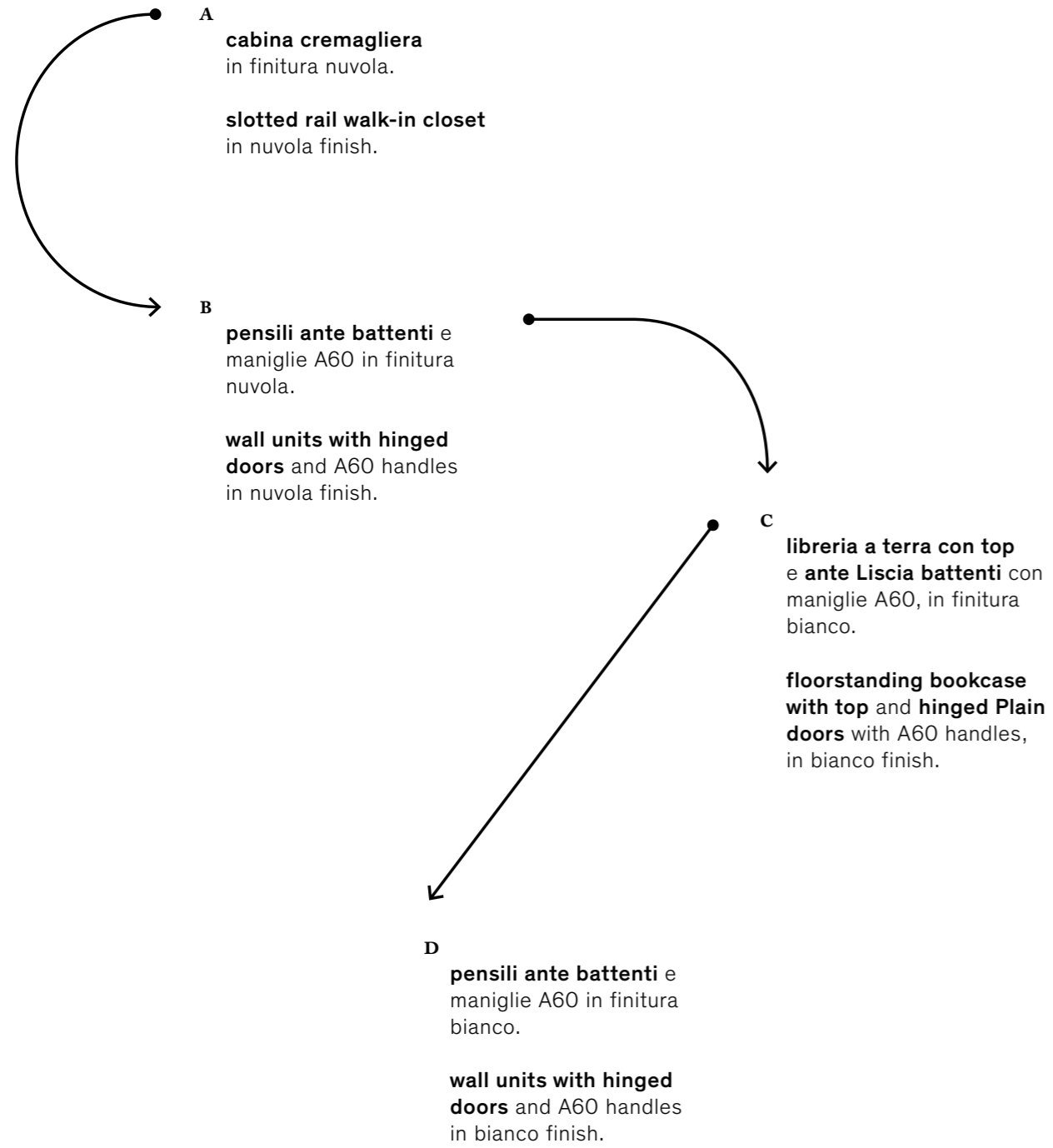



B

pensili
—
wall units

L—W 360 cm
H 91,5 cm
P—D 35,4 cm

A

cabina
cremagliera
—
slotted rail
walk-in closet

L—W 360 cm
H 161,3 cm
P—D 50,8 cm





D
pensili
—
wall units

L—W 360 cm
H 91,5 cm
P—D 35,4 cm

C
libreria a terra
con top
—
floorstanding
bookcase
with top

L—W 263 cm
H 110,8 cm
P—D 45,4 cm

KEY PRODUCT

UI.1



Cabina a spalla
senza schiena,
in finitura olmo
nordico.

**Walk-in closet
system with
load-bearing
side panels** with
no back panel,
in olmo nordico
finish.

UI.2



**Pensili e basi
a terra** con ante
battenti e cassettoni
in finitura frassino
juta con maniglie
A69 in finitura
brunito, **top** e
mensole in finitura
sabbia.

**Wall units and
floorstanding base
units** with hinged
doors and oversized
drawers in frassino
juta finish with A69
handles in bronze
finish, **top** and
shelves in sabbia
finish.

U2

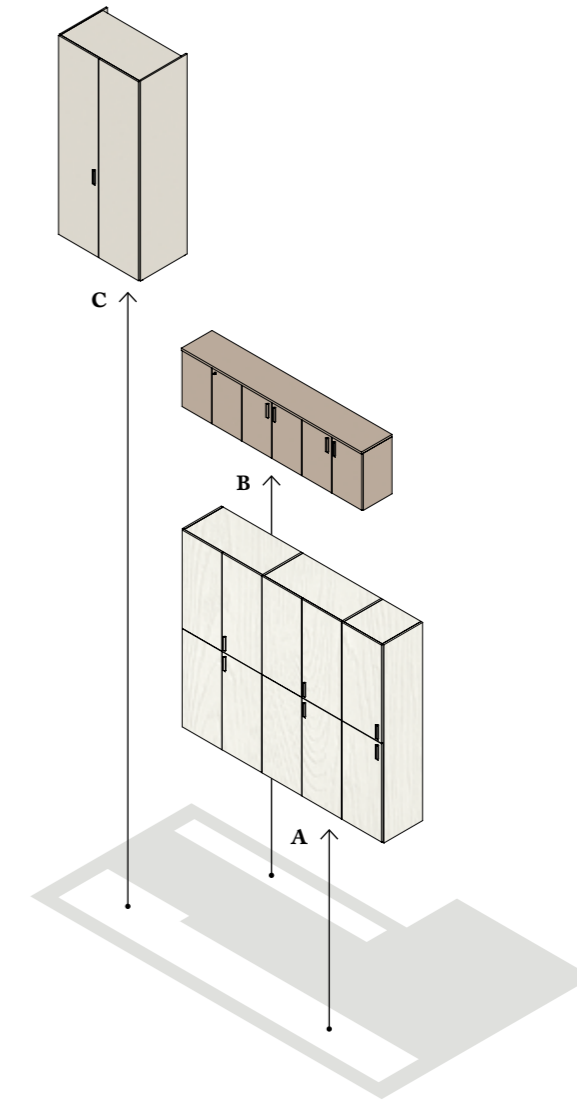
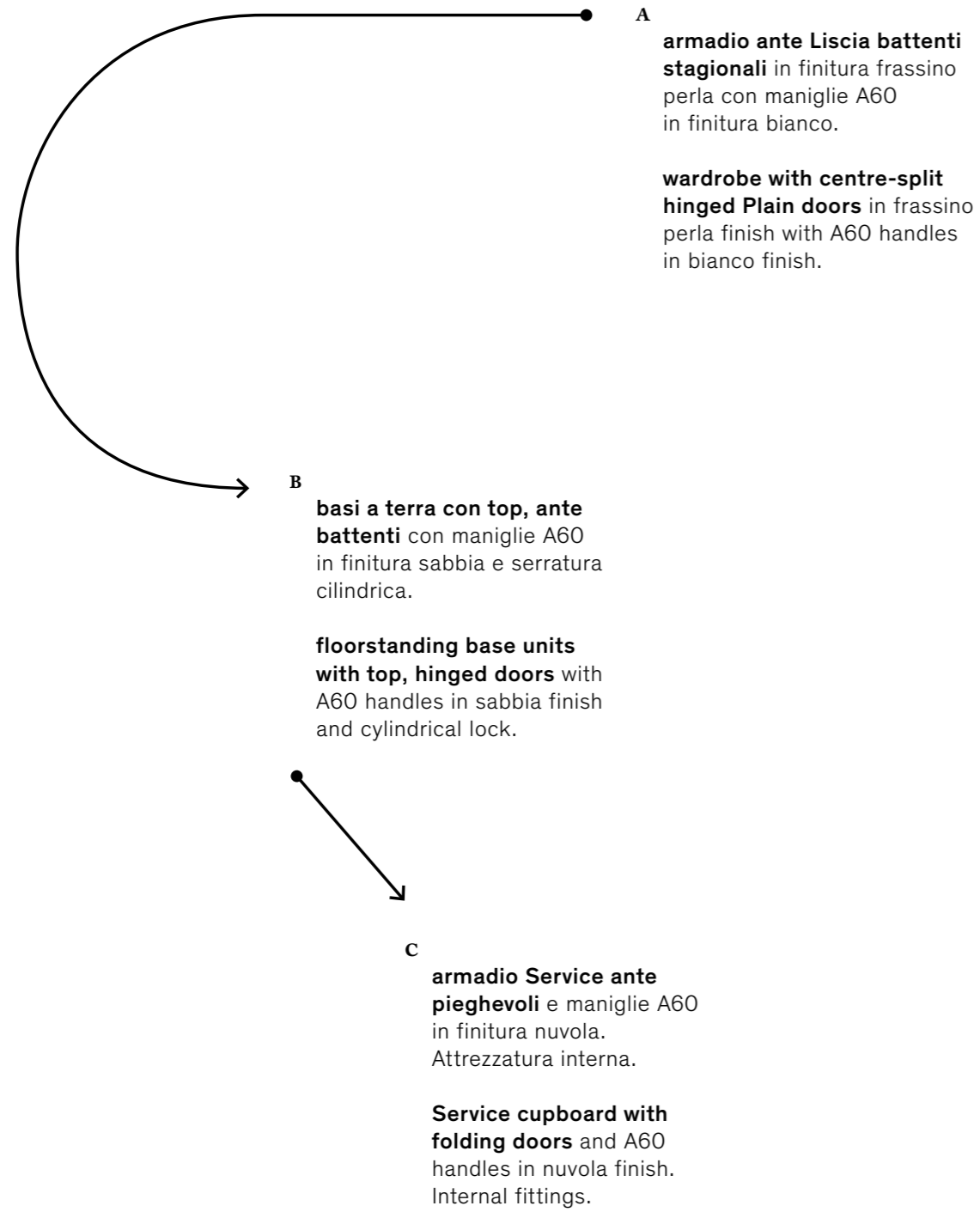



A

armadio ante
battenti
—
hinged door
wardrobe

L—W 302,5 cm
H 257,9 cm
P—D 60,6 cm



B

basi a terra
con top
—
floorstanding base
units with top

L—W 270 cm
H 77,9 cm
P—D 45,8 cm



C — KEY PRODUCT
**armadio
Service
ante
pieghevoli**
—
**Service
cupboard
with folding
doors**

L—W 121,1 cm
H 257,9 cm
P—D 72,4 cm

KEY PRODUCT

U2.1



Armadi Service ante battenti in finitura cashmere, **basi a terra** con ante battenti in finitura olmo shade, maniglie A28 e top in finitura bianco. **Pensili** ante battenti apertura push-pull in finitura olmo shade.

Service cupboards with hinged doors in cashmere finish, **floorstanding base units** with hinged doors in olmo shade finish, A28 handles and top in bianco finish. Hinged door **wall units** with push-to-open doors in olmo shade finish.

U2.2



Armadi Service ante battenti e maniglie A76 in finitura lavagna, con **libreria a terra** interna in finitura nuvola. Composizione **libreria a terra** con ripiani portascarpe in finitura nuvola, ante vetro trasparente, cassetti e cassettoni con maniglie A47 in finitura bianco, **anta Specchio** battente in finitura chiaro e **anta Profilo** battente in finitura bianco. Maniglie A93 nella medesima finitura.

Service cupboards with hinged doors and A76 handles in lavagna finish, with internal **floorstanding bookcase** in nuvola finish. **Floorstanding bookcase** configuration with shoe rack shelves in nuvola finish, transparent glass doors, regular and oversized drawers with A47 handles in bianco finish, hinged **Mirror door** in light finish and hinged **Profilo door** in bianco finish. A93 handles in the same finish.

U3

A
armadio ante Liscia scorrevoli in finitura lavagna con maniglie A57 in finitura titanio.

wardrobe with sliding Plain doors in lavagna finish with A57 handles in titanium finish.

B
scrivania in finitura olmo nordico e **mensola** in finitura bianco.

desk in olmo nordico finish and **shelf** in bianco finish.

C
composizione armadio a giorno in finitura nuvola.

open wardrobe configuration in nuvola finish.

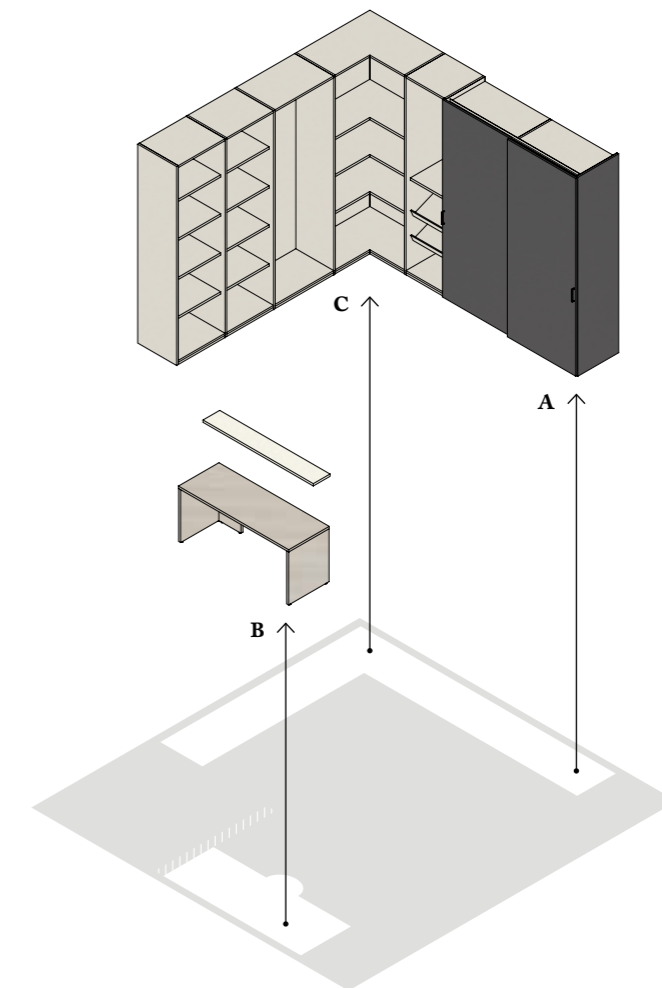



A

armadio ante
scorrevoli
—
sliding door
wardrobe

L—W 202,5 cm
H 257,9 cm
P—D 64,2 cm



B

scrivania
e mensola
—
desk and shelf

L—W 165 cm
H 73 cm
P—D 60,6 cm

L—W 165 cm
H 3 cm
P—D 25 cm

C — KEY PRODUCT

**composizione
armadio a giorno**
—
**open wardrobe
configuration**

L—W 382,5 cm
H 257,9 cm
P—D 169,8 cm



KEY PRODUCT

U3.1



Cabina cremagliera senza schiena, in finitura lavagna.

Slotted rail walk-in closet with no back panel, in lavagna finish.

U3.2



Sistema Cover in finitura lavagna, **mensole Cover Up** in finitura bianco e **armadio Light** ante battenti in finitura nuvola con maniglie A62 in finitura bianco.

Cover system in lavagna finish, **Cover Up shelves** in bianco finish and **Light wardrobe** with hinged doors in nuvola finish with A62 handles in bianco finish.

U4

- A**
basi sospese con top e cassettoni in finitura sabbia con maniglie A28 in finitura basalto.
wall-mounted base units with top and oversized drawers in sabbia finish with A28 handles in basalto finish.
- B**
panca scendiletto in finitura sabbia.
bed end bench in sabbia finish.
- C**
armadio ante Liscia battenti con angolo esterno in finitura frassino juta con maniglie A28 in finitura basalto, **anta Specchio battente** e maniglia A93 in finitura brunito.
wardrobe with hinged Plain doors and outside corner module in frassino juta finish with A28 handles in basalto finish, **tinted hinged Mirror door** and A93 handle in bronze finish.

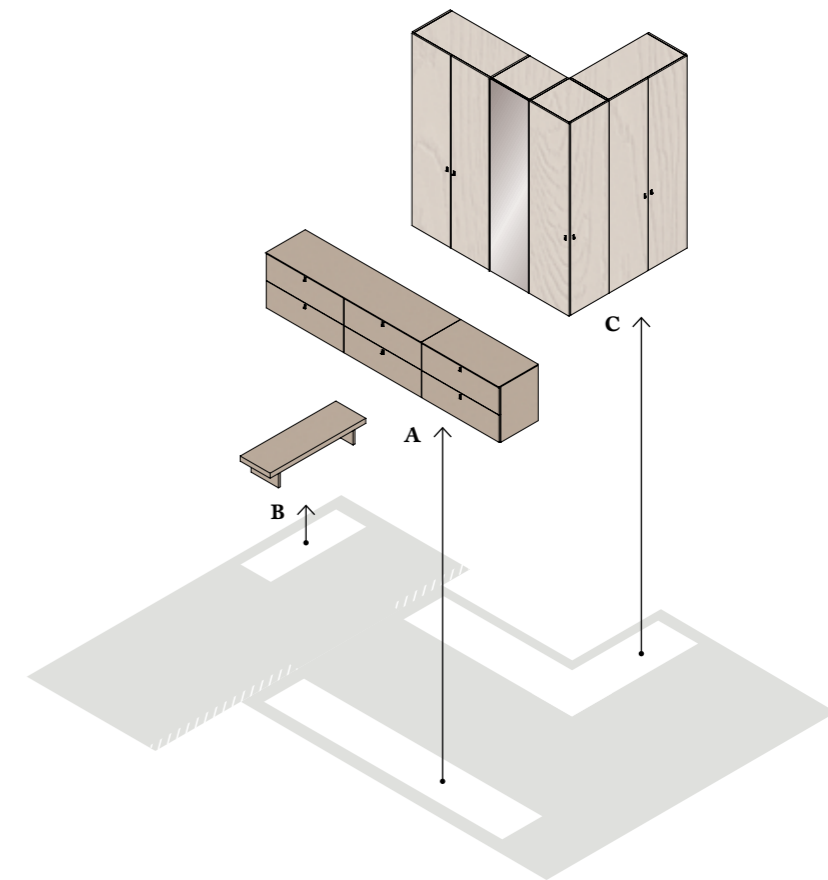

A

basi sospese
con top
—
wall-mounted base
units with top

L—W 360 cm
H 75,4 cm
P—D 61 cm



B
 panca scendiletto
 —
 bed end bench
 L—W 150 cm
 H 29 cm
 P—D 46,9 cm



C — KEY PRODUCT

**armadio ante
 battenti con
 angolo esterno
 —
 hinged door
 wardrobe
 with outside
 corner module**

L—W 183,5 cm
 H 257,9 cm
 P—D 243 cm

KEY PRODUCT

U4.1



Armadio ante Liscia battenti con angolo esterno ed interno in finitura olmo tabacco con maniglie A78 e **terminale sagomato** in finitura nuvola.

Wardrobe with hinged Plain doors and outside and inside corner module in olmo tabacco finish with A78 handles and **shaped end unit** in nuvola finish.

U4.2



Armadio ante Profilo battenti in finitura bianco e **angolo esterno** con **ante Specchio battenti** in finitura chiaro. Maniglie A93 in finitura bianco.

Wardrobe with hinged Profilo doors in bianco finish and **outside corner module** with **hinged Mirror doors** in light finish. A93 handles in bianco finish.

U5

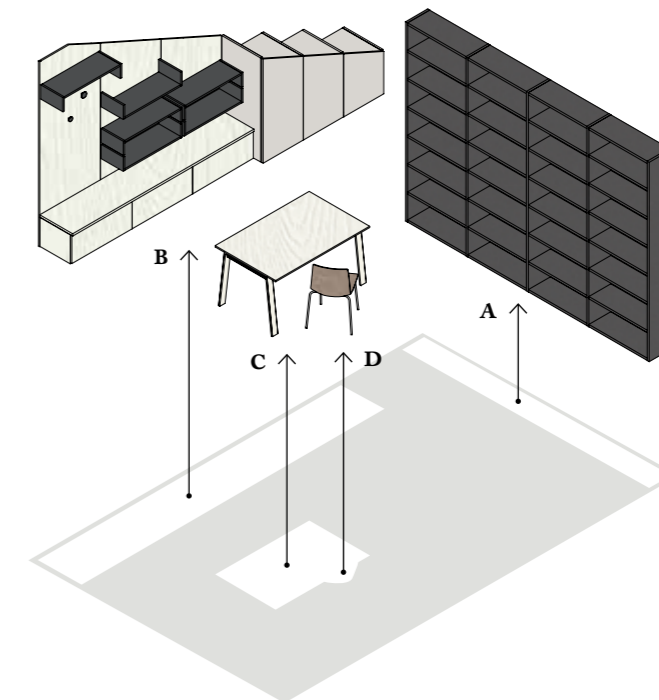
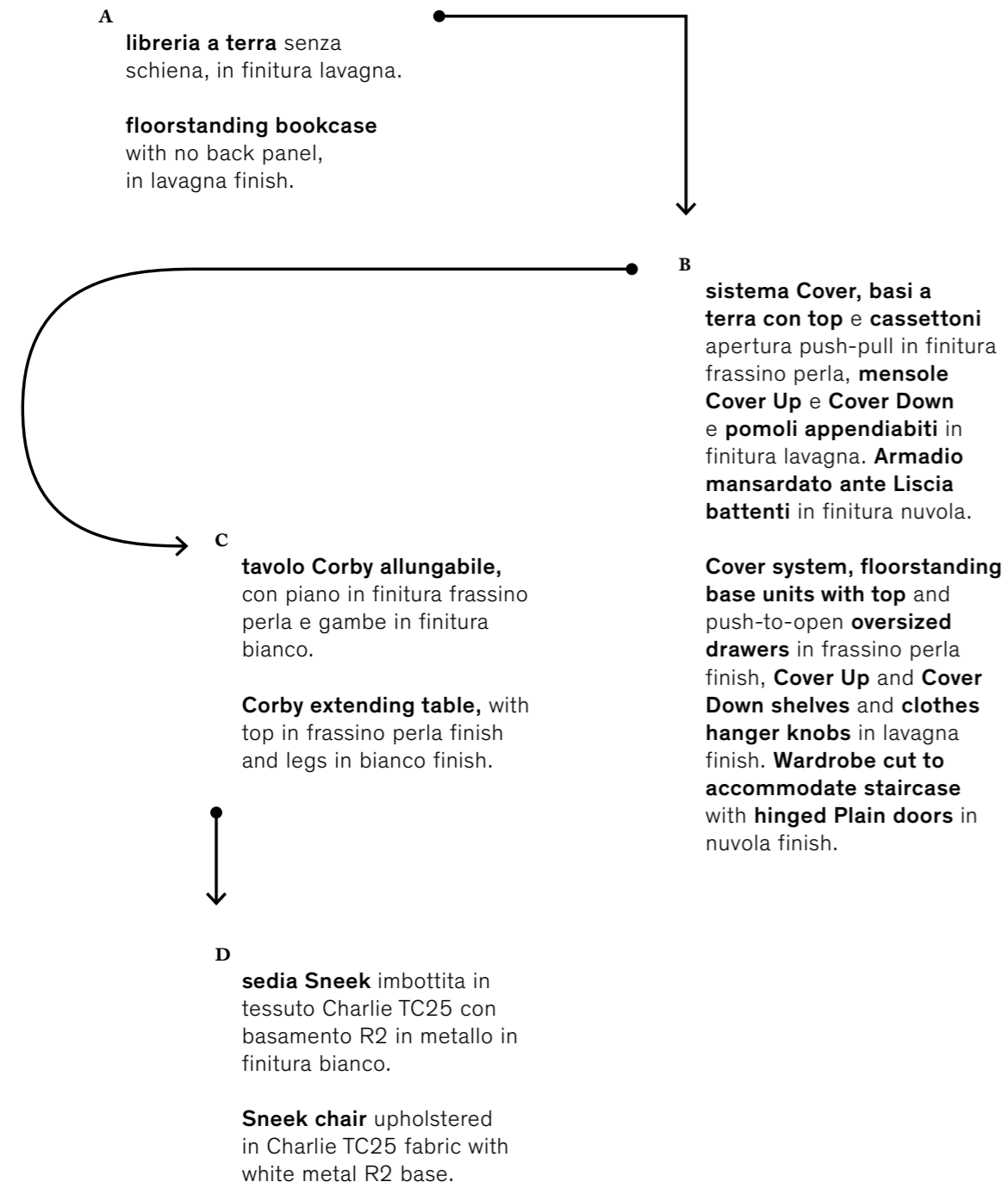



A
libreria a terra
—
floorstanding
bookcase

L—W 363 cm
H 257,9 cm
P—D 33 cm

B — KEY PRODUCT

**sistema Cover,
basi a terra
con top, pomoli
appendiabiti,
mensole Cover
Up e Cover
Down e armadio
mansardato**

**—
Cover system,
floorstanding base
units with top,
clothes hanger
knobs, Cover Up
and Cover Down
shelves and
wardrobe cut to
accommodate
staircase**

L—W 453,5 cm
H 257,9 | 57 cm
P—D 61 cm





C, D

tavolo Corby
e sedia Sneek
—
Corby table
and Sneek chair

L—W 140/260 cm
H 75 cm
P—D 90 cm

KEY PRODUCT

U5.1



Sistema Cover
in finitura bianco,
mensole Cover Up
e **Cover Down**, basi a
terra con top
e maniglie A68 in
finitura cemento,
panca scendiletto e
pomoli appendiabiti
in finitura olmo shade.

Cover system
in bianco finish,
Cover Up and **Cover**
Down shelves,
floorstanding base
units with top
and A68 handles
in cemento finish,
bed end bench
and **clothes hanger**
knobs in olmo shade
finish.

U5.2



Sistema Cover in finitura
sabbia, **scrittoio** a
parete in finitura nuvola,
basi sospese con top
e cassettoni apertura
push-pull in finitura
lavagna. **Mensole Cover**
Up e **Cover Down** in
finitura nuvola e lavagna,
sedia Sneek imbottita in
tessuto Maia TMO6 con
basamento R1 in metallo
in finitura bianco.

Cover system in sabbia
finish, wall-mounted **desk**
in nuvola finish, **wall-**
mounted base units with
top and push-to-open
oversized drawers in
lavagna finish. **Cover Up**
and **Cover Down shelves**
in nuvola and lavagna
finishes, **Sneek chair**
upholstered in Maia TMO6
fabric with white metal R1
base.

U6

A
**armadi Service ante
 pieghevoli** in finitura
 frassino perla, maniglia A73
 in finitura bianco, **asse da
 stiro ribaltabile**.

**Service cupboards with
 folding doors** in frassino
 perla finish, A73 handle in
 bianco finish, **drop-down
 ironing board**.



B
**piano lavanderia con
 fianchi ad L e cesti
 portabiancheria su ruote**
 in finitura canapa.

**laundry top with L-shaped
 sides and laundry baskets
 on castors** in canapa finish.

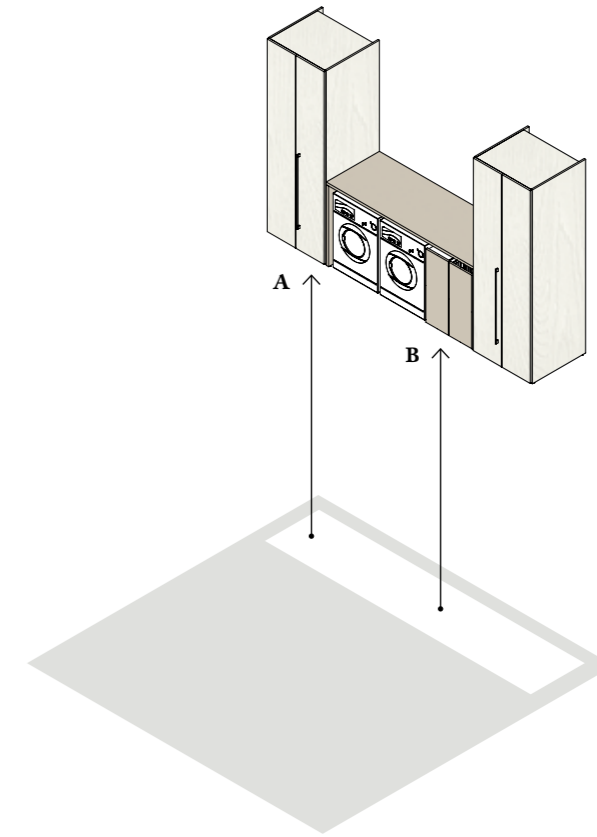



A
armadi Service
—
Service cupboards
L—W 76,1 cm
H 221,3 cm
P—D 72,4 cm

B — KEY PRODUCT

**piano lavanderia
e cesti
portabiancheria
—
laundry top
and laundry
baskets**

L—W 195 cm
H 96,2 cm
P—D 70 cm



KEY PRODUCT

U6.1



Piano lavanderia con fianchi ad L, cesto portabiancheria su ruote in finitura basalto, **pensili** ante battenti in finitura olmo nordico, apertura push-pull e serratura cilindrica, con **tubo appendiabiti**. **Sistema Cover** in finitura olmo nordico con **mensola Elle**, **mensole Cover Down con tubo appendiabiti** e **mensole Cover Up** in finitura basalto.

Laundry top with L-shaped sides and laundry baskets on castors in basalto finish, **wall units** with push-to-open hinged doors in olmo nordico finish with cylindrical lock, with **hanging rail**. **Cover system** in olmo nordico finish with **Elle shelf**, **Cover Down shelves with hanging rail** and **Cover Up shelves** in basalto finish.

U6.2



Piano lavanderia con fianchi ad L in finitura nuvola, **cassettiera** in finitura cemento su ruote in finitura lavagna e maniglie A54 in finitura nuvola. **Pensili** ante battenti e ripiani in vetro trasparente. **Libreria a terra** a giorno in finitura cemento e con ante Liscia battenti in finitura nuvola, maniglie A54 nella medesima finitura.

Laundry top with L-shaped sides in nuvola finish, **drawer unit** in cemento finish on castors in lavagna finish and A54 handles in nuvola finish. **Wall units** with hinged doors and transparent glass shelves. Open **floorstanding bookcase** in cemento finish with hinged Plain doors in nuvola finish, A54 handles in the same finish.

un'ampia
gamma
di elementi

diversi per
colore, forma
e dimensioni

capaci
di caratterizzare

ogni spazio

a wide range of
elements that differ
in colour, shape
and size, giving
each space
a distinctive look.

MATERIALI

—
MATERIALS

p. 214

MANIGLIE

—
HANDLES

p. 218

TAVOLI

—
TABLES

p. 222

LETTI

—
BEDS

p. 226

COMÒ, COMODINI E SETTIMINI

—
CHESTS OF DRAWERS,
BEDSIDE TABLES AND TALLBOYS

p. 246

ARMADI, CABINE,
BASI, PENSILI,
LIBRERIE E SISTEMA COVER

—
WARDROBES, WALK-IN CLOSETS,
BASE UNITS, WALL UNITS,
BOOKCASES AND COVER SYSTEM

p. 250

ATTREZZATURE PER ARMADI
E CABINE ARMADIO

—
WARDROBE AND WALK-IN
CLOSET FITTINGS

p. 262

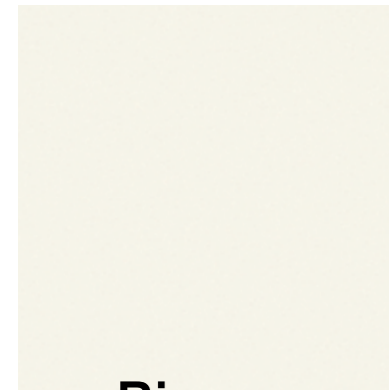

Bianco

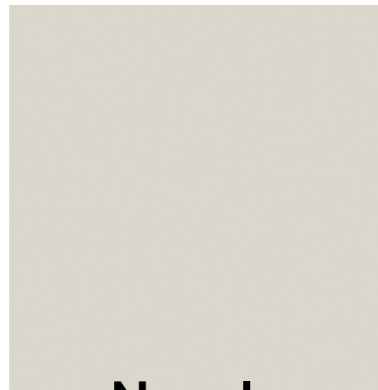

Nuvola

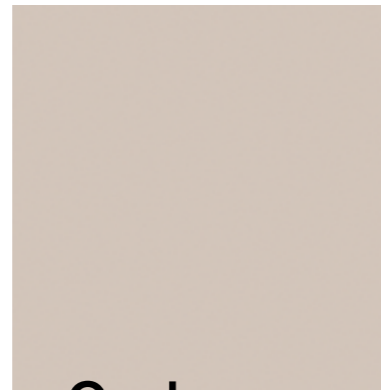

Cashmere



Canapa

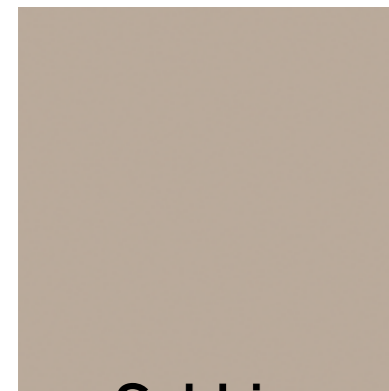

Sabbia

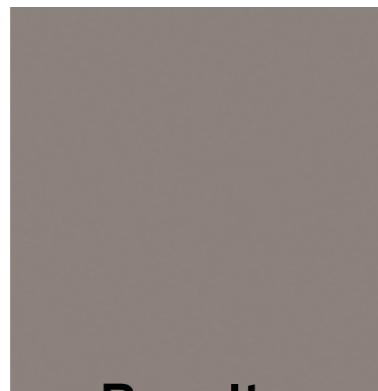

Basalto



Cemento



Lavagna



Vetro fumè
Smoked glass

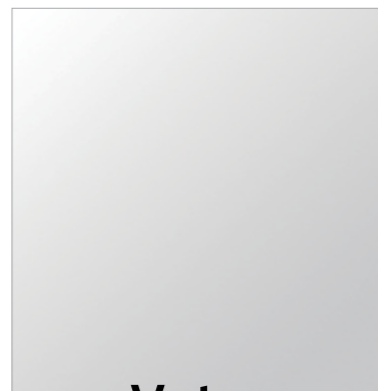

Vetro trasparente
Transparent glass



Olmo shade



Olmo nordico



Olmo tabacco



Frassino juta



Frassino perla

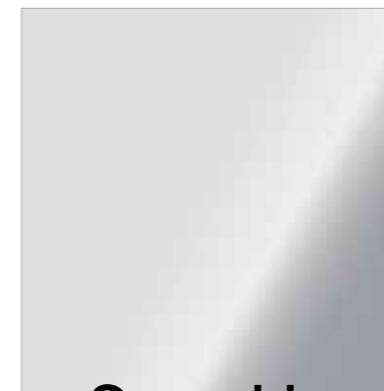

Specchio chiaro
Light mirror



Specchio brunito
Tinted mirror

MATERIALI — tessuti ed ecopelle

Maia

tessuto/fabric



TM06

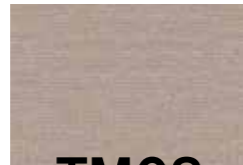

TM08



TM10



TM13



TM15



TM16



TM17



TM23



TM28



TM30



TM40

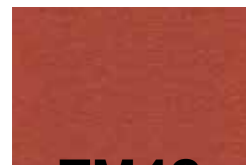

TM42



TM45

Tex

tessuto/fabric



TT01



TT03



TT06



TT10



TT12



TT16



TT17



TT18

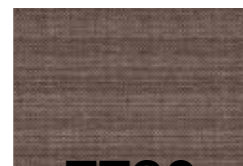

TT30

Charlie

tessuto/fabric

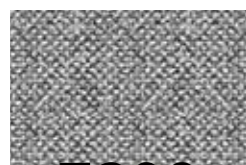

TC06



TC12



TC25



TC39



TC43

MATERIALS — fabrics and imitation leather

Slim

ecopelle/
imitation leather



TS01



TS06



TS07

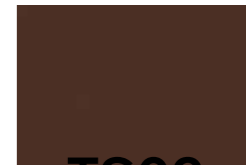

TS09

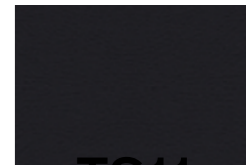

TS11



TS17



TS18

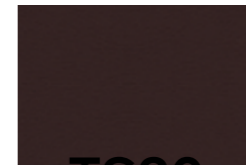

TS20



TS25

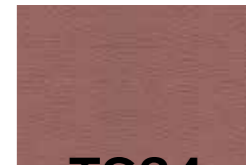

TS34



TS39



TS40



TS41

Feltro

felt



TF01



TF02



TF03



TF07



TF08



TF09



TF11

MANIGLIE — panoramica

HANDLES — overview



A40



A47



A51

A52



A53



A54



A57

A63



A58



A59



A60



A68

A69



A72

A74



A28



A96



A66

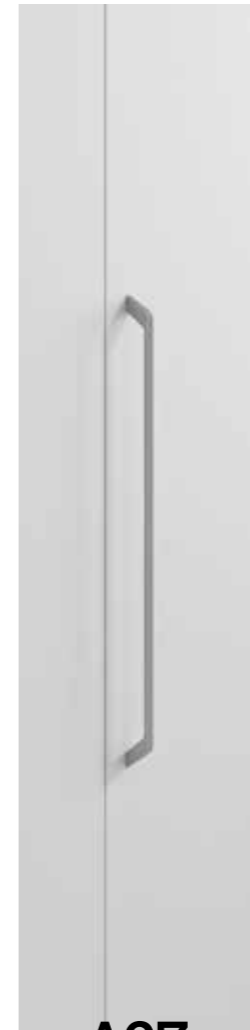

A67



A70

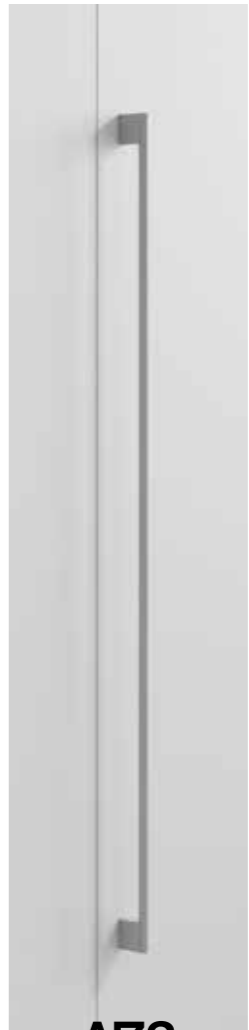

A73

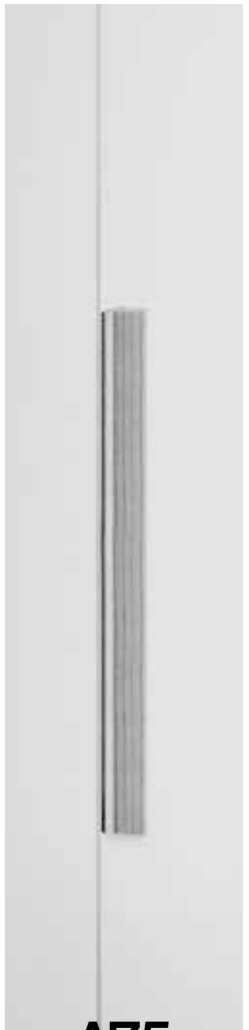

A75

MANIGLIE — *panoramica*HANDLES — *overview*

INFO

La maniglia **A93** è disponibile per anta Profilo, anta Cornice e anta Specchio battente e pieghevole; **A94** per anta Piegia; **A95** per anta Gola. Tutte le altre maniglie sono disponibili per anta Liscia.

—
Handle **A93** is an option on Profilo doors, Cornice doors and Mirror doors in both hinged and folding versions; **A94** on Piegia doors; **A95** on Gola doors. All the other handles are an option on Plain doors.

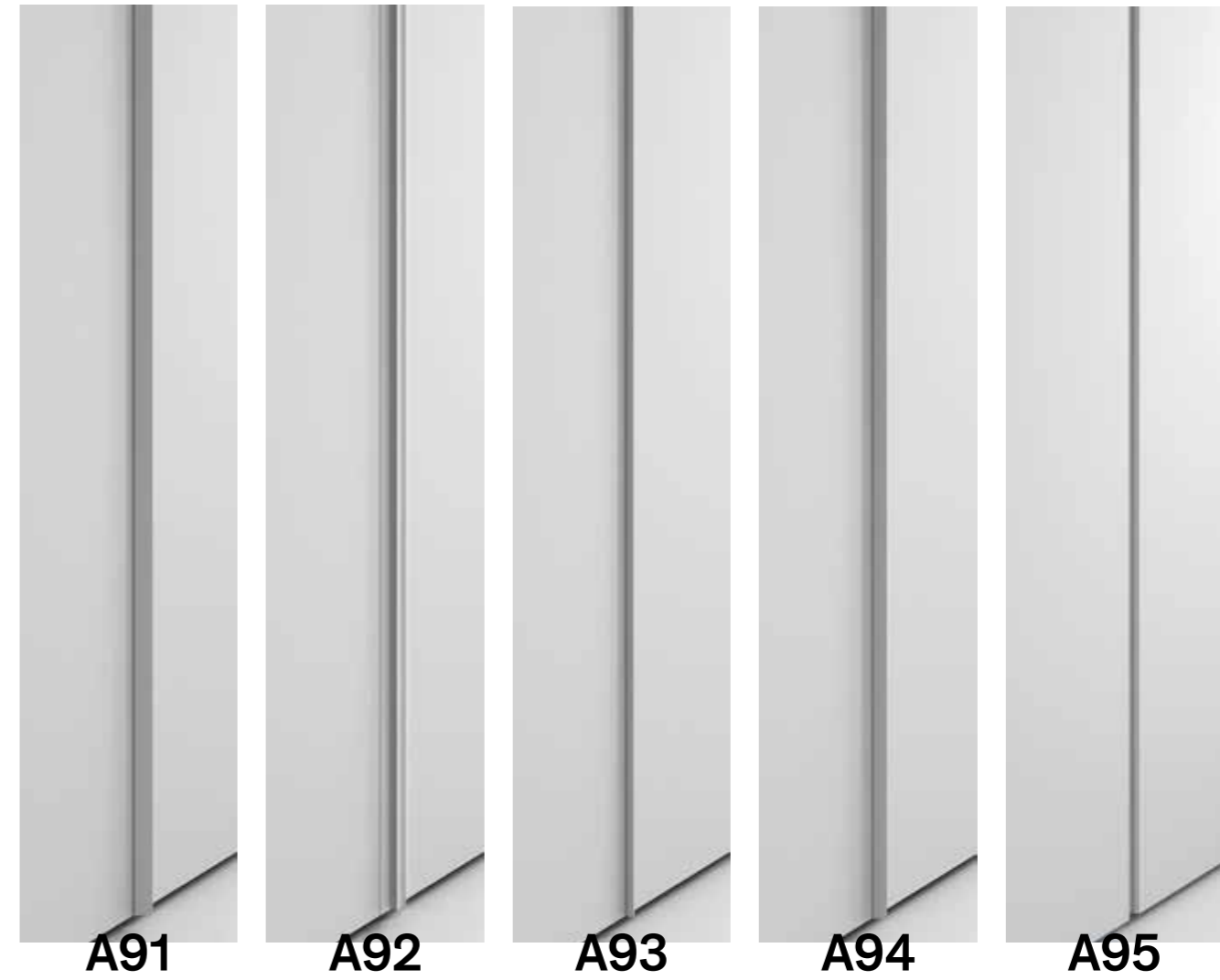

TAVOLI — panoramica

INFO

Tavolo Corby allungabile, disponibile anche in versione a **penisola**, con piano spessore 1,8 cm in tutte le finiture a catalogo e gambe in metallo in finitura bianco e brunito. Dimensioni tavolo chiuso/aperto nelle due versioni: L 140/260 cm H 75 cm P 90 cm.

Corby extending table, also available in **peninsula** version, with 1,8 cm-thick top in any of the finishes from the catalogue and metal legs in bianco and bronze finishes. Closed/open table dimensions in both versions: W 140/260 cm H 75 cm D 90 cm.



Corby
chiuso/closed



Corby
aperto/open

TABLES — overview



Corby
penisola chiuso/closed peninsula



Corby
penisola aperto/open peninsula

TAVOLI — panoramica

INFO

Tavolo Leone allungabile

disponibile nelle versioni **Small** (quadrato) e **Large** (rettangolare).

Con piano, spessore 1,8 cm, disponibile in tutte le finiture a catalogo e gambe in metallo in finitura bianco e brunito. Dimensioni tavolo Leone Small chiuso/aperto: L 90/150 cm H 75,6 cm e P 90 cm. Dimensioni tavolo Leone Large chiuso/aperto: L 120/220 cm H 75,6 cm e P 90 cm.

Extending Leone table

comes in **Small** (square) and **Large** (rectangular) versions.

With top, 1,8 cm thick, available in any finish from the catalogue and metal legs in bianco and bronze finishes.

Closed/open Leone Small table dimensions: W 90/150 cm H 75,6 cm and D 90 cm.

Closed/open Leone Large table dimensions: W 120/220 cm H 75,6 cm and D 90 cm.

**Lione**

Small chiuso/Small closed

**Lione**

Large chiuso/Large closed

TABLES — overview

INFO

Tavolo Vigo con piano in vetro in finitura bianco, spessore 1,2 cm, e gambe in metallo disponibili in finitura nuvola, bianco e brunito. Dimensioni: L 120 | 180 | 200 cm H 75 cm P 100 cm.

Vigo table with glass top in bianco finish, 1,2 cm thick, and metal legs available in nuvola, bianco and bronze finishes.

Dimensions: W 120 | 180 | 200 cm H 75 cm D 100 cm.

**Vigo**

LETTI — *giroletti*

R70
dritto/straight



R70
stondato/rounded



R180
dritto/straight



R180
stondato/rounded



R18Z
dritto/straight



R18Z
stondato/rounded

BEDS — *bed surrounds*

R120

LETTI — *giroletti*

R290
dritto/straight



R290
stondato/rounded

BEDS — *bed surrounds*

INFO

I giroletti sono abbinabili a tutte le testiere e sono disponibili in tutte le finiture a catalogo.

—
Bed surrounds can be paired with any headboard and are available in any finish from the catalogue.

LETTI IMBOTTITI — *giroletti*

**Kora,
Thika**



**Isla, Jerez, York,
Turca imbottito**
padded Platform

PADDED BEDS — *bed surrounds*

INFO

I giroletti imbottiti sono sfoderabili e disponibili nei diversi tessuti ed ecopelle a catalogo.

—
Upholstered bed surrounds come with removable covers and are available in the various fabric and imitation leather options from the catalogue.

LETTI — testiere

INFO

Tutte le testiere sono disponibili nelle diverse finiture a catalogo e sono combinabili con tutti i giroletti.

All headboards are available in your choice of finish from the catalogue and can be used in conjunction with all surrounds.

**Suez****Suez**

con cuffia Ennis/with Ennis headboard cover

**Suez**

con cuffia Bled/with Bled headboard cover

**Suez
Maxi****Este****Thun****Mostar****Lagos**

testiera imbottita/
padded headboard

**Turca**

Platform bed

**Kora****Jerez****Isla****Turca
imbottito**

padded Platform

**Thika****York**

PADDED BEDS — headboards

INFO

Tutte le testiere imbottite sono sfoderabili e disponibili nei diversi tessuti ed ecopelle a catalogo.

All padded headboards come with removable covers and are available in the various fabric and imitation leather options from the catalogue.

LETTO CARDIFF — *testiere con giroletti in appoggio*

CARDIFF BED — *freestanding headboard and bed surround combos*

INFO

La testiera Cardiff è disponibile in 2 altezze e con il copritestiera Singer non sfoderabile.

The Cardiff headboard comes in 2 heights and can be ordered with the non-removable Singer headboard cover.



Cardiff



Cardiff

con copritestiera Singer/
with Singer headboard cover

LETTO ARNAD — *testiere con giroletti in appoggio*

ARNAD BED — *freestanding headboard and bed surround combos*

INFO

La testiera Arnad è disponibile con retroilluminazione a LED e anche nella versione imbottita sfoderabile.

The Arnad headboard comes with LED backlighting and also in the padded version with removable upholstery.



Arnad

LETTO ARNAD — *composizioni e dimensioni*

ARNAD BED — *configurations and dimensions*

INFO

Esempi di composizioni e dimensioni disponibili della testiera Arnad.

Examples of configuration and size options for Arnad headboard.

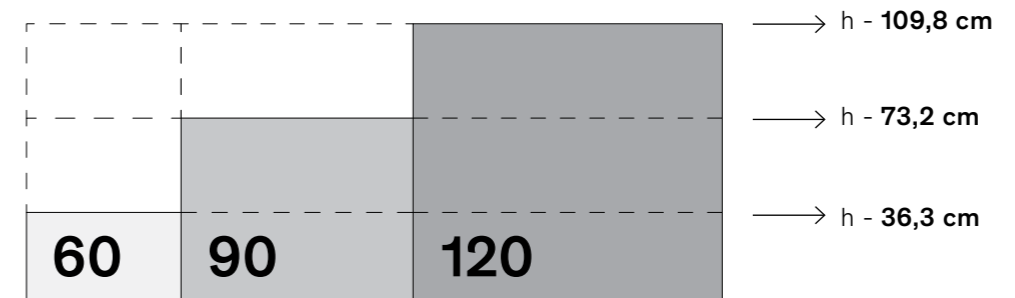

LETTI — *panoramica***Suez**

In finitura bianco, con giroletto R120 con gambe.

In bianco finish, with R120 bed surround with legs.

**Suez** con cuffia Ennis/with Ennis headboard cover

In finitura frassino juta, con giroletto R120 con gambe, cuffia Ennis in tessuto Maia TM17.

In frassino juta finish, with R120 bed surround with legs, Ennis cover in Maia TM17 fabric.

BEDS — *overview*

INFO

La testiera del letto Suez è disponibile anche con cuffia imbottita Ennis o Bled. Le cuffie Ennis e Bled sono disponibili in tutti i tessuti escluso l'ecopelle.

The Suez bed headboard also comes with padded Ennis or Bled cover. Ennis and Bled headboard covers are available in all fabric options except imitation leather.

**Suez** con cuffia Bled/with Bled headboard cover

In finitura sabbia, con giroletto R18Z stonato, cuffia Bled in tessuto Maia TM08 e fettuccia a contrasto in colore grafite.

In sabbia finish, with rounded R18Z bed surround, Bled headboard cover in Maia TM08 fabric and contrasting graphite-coloured piping.

**Suez Maxi**

In finitura cemento, con giroletto R180 stonato, gambe in finitura brunito.

In cemento finish, with rounded R180 bed surround, legs in bronze finish.

LETTI — *panoramica*BEDS — *overview***Este**

In finitura olmo tabacco, con giroletto R120 con gambe.

In olmo tabacco finish, with R120 bed surround with legs.

**Mostar**

In finitura basalto, con giroletto R70 stondato.

In basalto finish, with rounded R70 bed surround.

**Thun**

In finitura cashmere, con giroletto R290 stondato.

In cashmere finish, with rounded R290 bed surround.

**Lagos**

Testiera imbottita sfoderabile in tessuto Charlie TC06 e giroletto R290 dritto in finitura sabbia.

Padded headboard with removable upholstery in Charlie TC06 fabric and straight R290 bed surround in sabbia finish.



Turca/Platform bed

In finitura bianco, disponibile solo con giroletto R120 con gambe.

In bianco finish, only available with R120 bed surround with legs.



Kora

In tessuto sfoderabile Tex TT06.

Covered in removable Tex TT06 fabric.



Thika

In tessuto sfoderabile Tex TT10.

Covered in removable Tex TT10 fabric.

LETTI IMBOTTITI — *panoramica*PADDED BEDS — *overview*

Isla

In tessuto sfoderabile
Maia TM08.

Covered in removable
Maia TM08 fabric.



Turca imbottito/padded Platform bed

In tessuto sfoderabile
Maia TM08.

Covered in removable
Maia TM08 fabric.



Jerez

In tessuto sfoderabile
Maia TM40.

Covered in removable
Maia TM40 fabric.



York

In tessuto sfoderabile
Tex TT30.

Covered in removable
Tex TT30 fabric.

TESTIERE CON GIROLETTI IN APPOGGIO — *panoramica***Cardiff**

In finitura olmo shade, con giroletto R180 dritto e gambe in finitura bianco.

In olmo shade finish, with straight R180 bed surround and legs in bianco finish.

**Cardiff**

In finitura bianco, con giroletto Turca imbottito in tessuto sfoderabile Tex TT01, copritestiera Singer nel medesimo tessuto non sfoderabile.

In bianco finish, with padded Platform bed surround covered in removable Tex TT01 fabric, Singer headboard cover in the same non-removable fabric.

FREESTANDING HEADBOARD AND BED SURROUND COMBOS — *overview***Arnad**

In finitura cashmere e tessuto sfoderabile Maia TM10, giroletto R70 stonato in finitura cashmere.

In cashmere finish and covered in removable Maia TM10 fabric, rounded R70 bed surround in cashmere finish.

**Arnad**

In finitura frassino perla e tessuto sfoderabile Maia TM40 e TM28, giroletto R18Z dritto in finitura frassino perla.

In frassino perla finish and covered in removable Maia TM40 and TM28 fabric, straight R18Z bed surround in frassino perla finish.

LETTI CON MECCANISMO RIBALTABILE — *panoramica*

INFO

I letti con meccanismo ribaltabile sono disponibili in tutte le finiture e tessuti presenti a catalogo.

Beds with drop-down mechanism are available in any of the finishes and fabrics from the catalogue.



Letto con meccanismo ribaltabile

In finitura olmo nordico, maniglie A57 in finitura bianco.

Bed with drop-down mechanism

In olmo nordico finish, A57 handles in bianco finish.



Letto con meccanismo ribaltabile, divano e mensola

In finitura basalto, divano in tessuto Charlie TC12 e fettuccia a contrasto in colore ruggine, mensola in finitura sabbia.

Bed with drop-down mechanism, sofa and shelf

In basalto finish, sofa in Charlie TC12 fabric and contrasting rust-coloured piping, shelf in sabbia finish.

BEDS WITH DROP-DOWN MECHANISM — *overview*

Letto con meccanismo ribaltabile con tavolo

In finitura canapa, tavolo con piano in finitura bianco.

Bed with drop-down mechanism with table

In canapa finish, table featuring top in bianco finish.

LETTI CON MECCANISMO RIBALTABILE — *panoramica*BEDS WITH DROP-DOWN MECHANISM — *overview*

Letto con meccanismo ribaltabile orizzontale - inferiore
In finitura frassino juta con libreria e maniglia A68 in finitura bianco.

Bed with horizontal drop-down mechanism - bottom section
In frassino juta finish with bookcase and A68 handle in bianco finish.

LETTI CON MECCANISMO RIBALTABILE — *panoramica*BEDS WITH DROP-DOWN MECHANISM — *overview*

Letto con meccanismo ribaltabile orizzontale
In finitura frassino perla, maniglie A68 in finitura bianco, cuffie di protezione in tessuto tecnico.

Bed with horizontal drop-down mechanism
In frassino perla finish, A68 handles in bianco finish, guard rail covers in technical fabric.



Letto con meccanismo ribaltabile orizzontale - superiore
In finitura olmo tabacco, schiena in finitura sabbia, maniglia A68 in finitura bianco, cuffie di protezione in tessuto tecnico.

Bed with horizontal drop-down mechanism - top section
In olmo tabacco finish, back panel in sabbia finish, A68 handle in bianco finish, guard rail covers in technical fabric.

DIVANO LETTO — *panoramica*SOFA BED — *overview*

Divano letto

In tessuto sfoderabile Maia TM17 con fettuccia a contrasto in colore grigio.

Sofa bed

Covered in removable Maia TM17 fabric with contrasting grey piping.

INFO

I divani letto, con rivestimento sfoderabile, non sono disponibili in tessuto ecopelle Slim.

— Sofa beds with removable covers, not available in Slim imitation leather fabric.

COMÒ, COMODINI E SETTIMINI — *panoramica*

Atene



Stoccolma

CHESTS OF DRAWERS, BEDSIDE TABLES AND TALLBOYS — *overview*

Praga



Oslo

INFO

Le collezioni notte Praga e Oslo sono disponibili con tutte le maniglie per cassetti.

—
The Praga and Oslo bedroom furniture collections are available with any of the drawer handle options.

COMÒ, COMODINI E SETTIMINI — *panoramica*

CHESTS OF DRAWERS, BEDSIDE TABLES AND TALLBOYS — *overview*



Londra



Bilbao



Bonn

ARMADI ANTA BATTENTE — panoramica

HINGED DOOR WARDROBES — overview

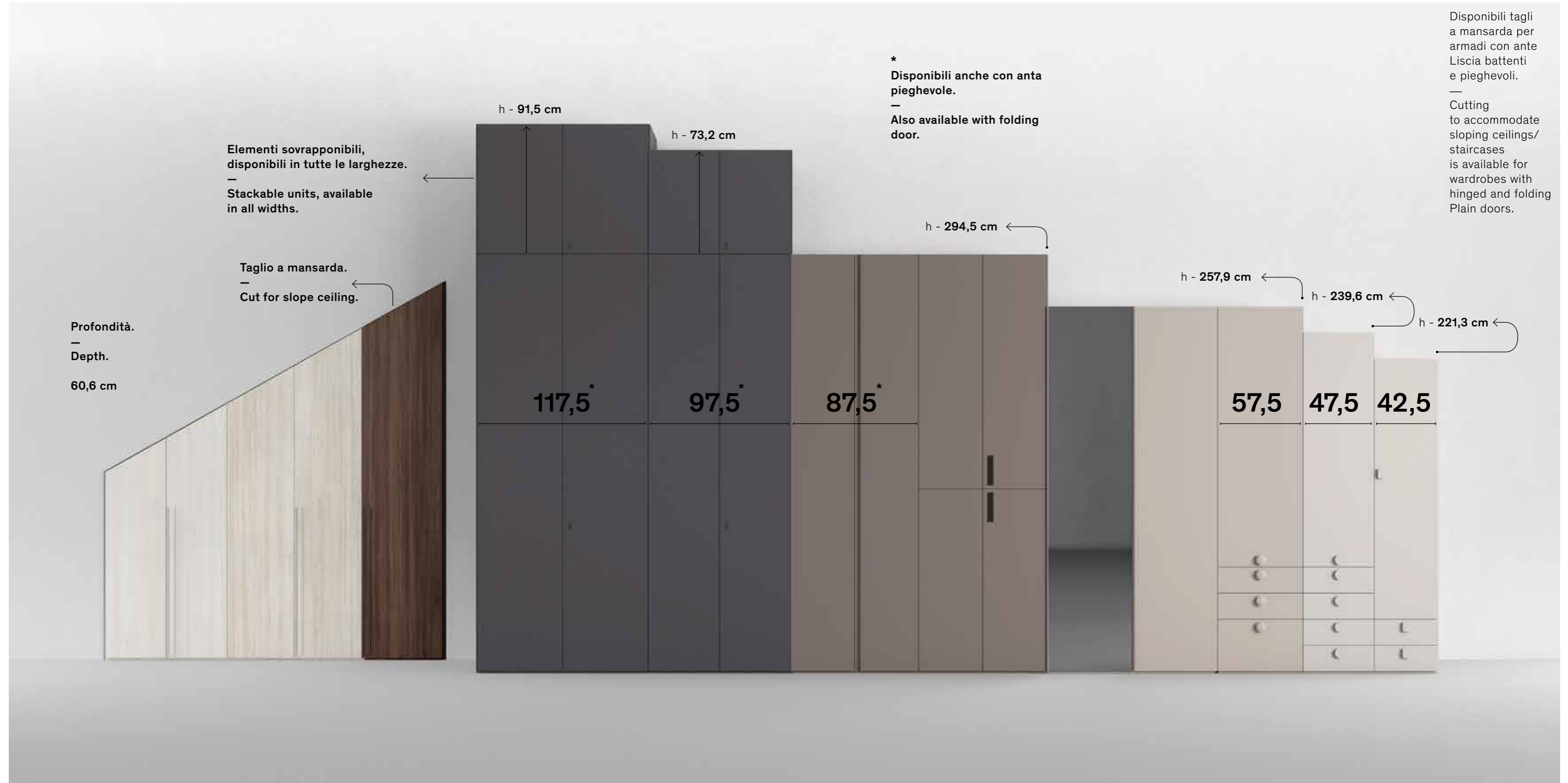

ARMADI A PONTE — panoramica

BRIDGING WARDROBES — overview



ARMADI SCORREVOLI — panoramica

SLIDING DOOR WARDROBES — overview



CABINA ARMADIO — panoramica

WALK-IN CLOSET — overview



CABINA A SPALLA — panoramica

WALK-IN CLOSET SYSTEM WITH LOAD-BEARING SIDE PANELS — overview

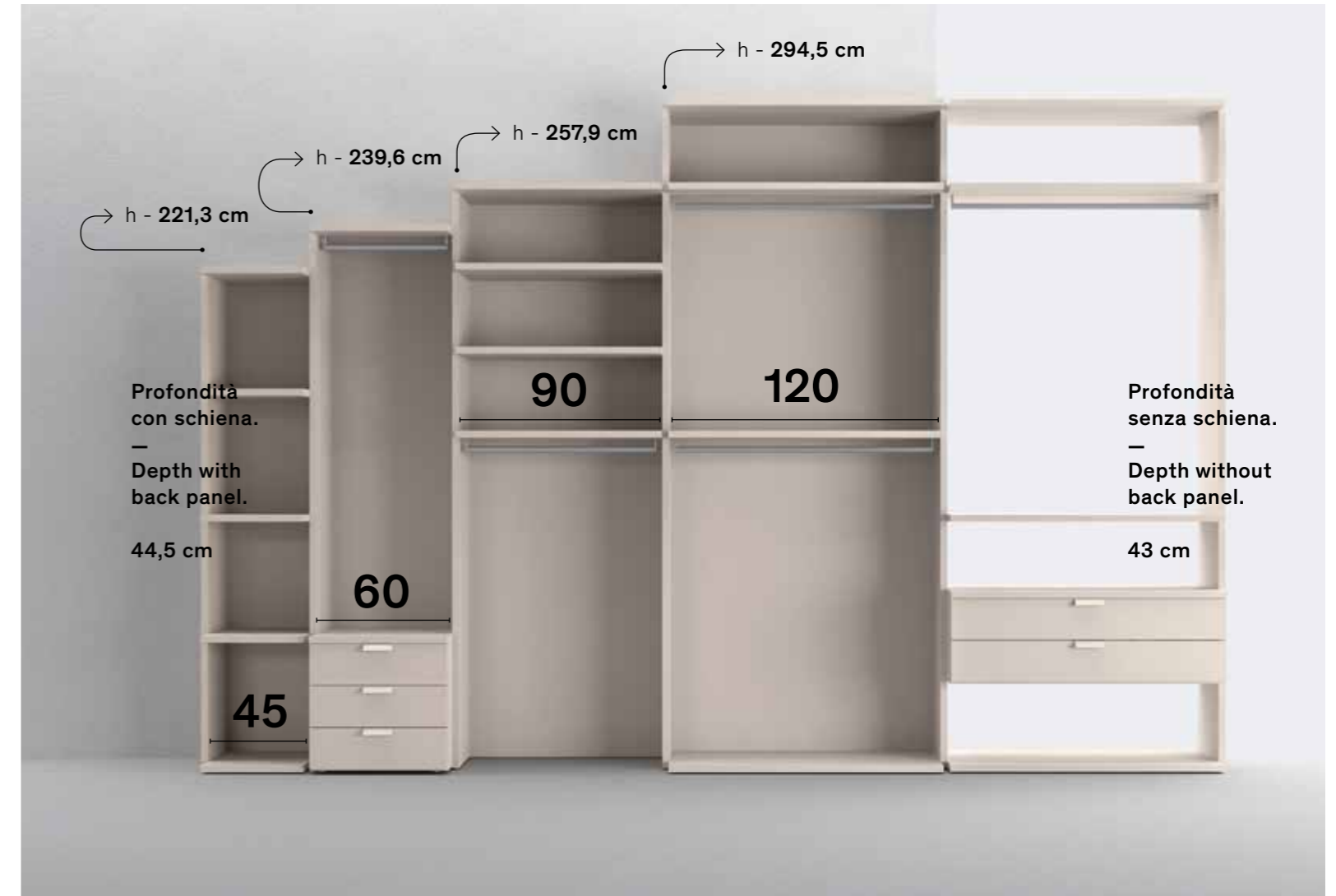

CABINA CREMAGLIERA — panoramica

SLOTTED RAIL WALK-IN CLOSET — overview



BASI E PENSILI — panoramica

BASE AND WALL UNITS — overview

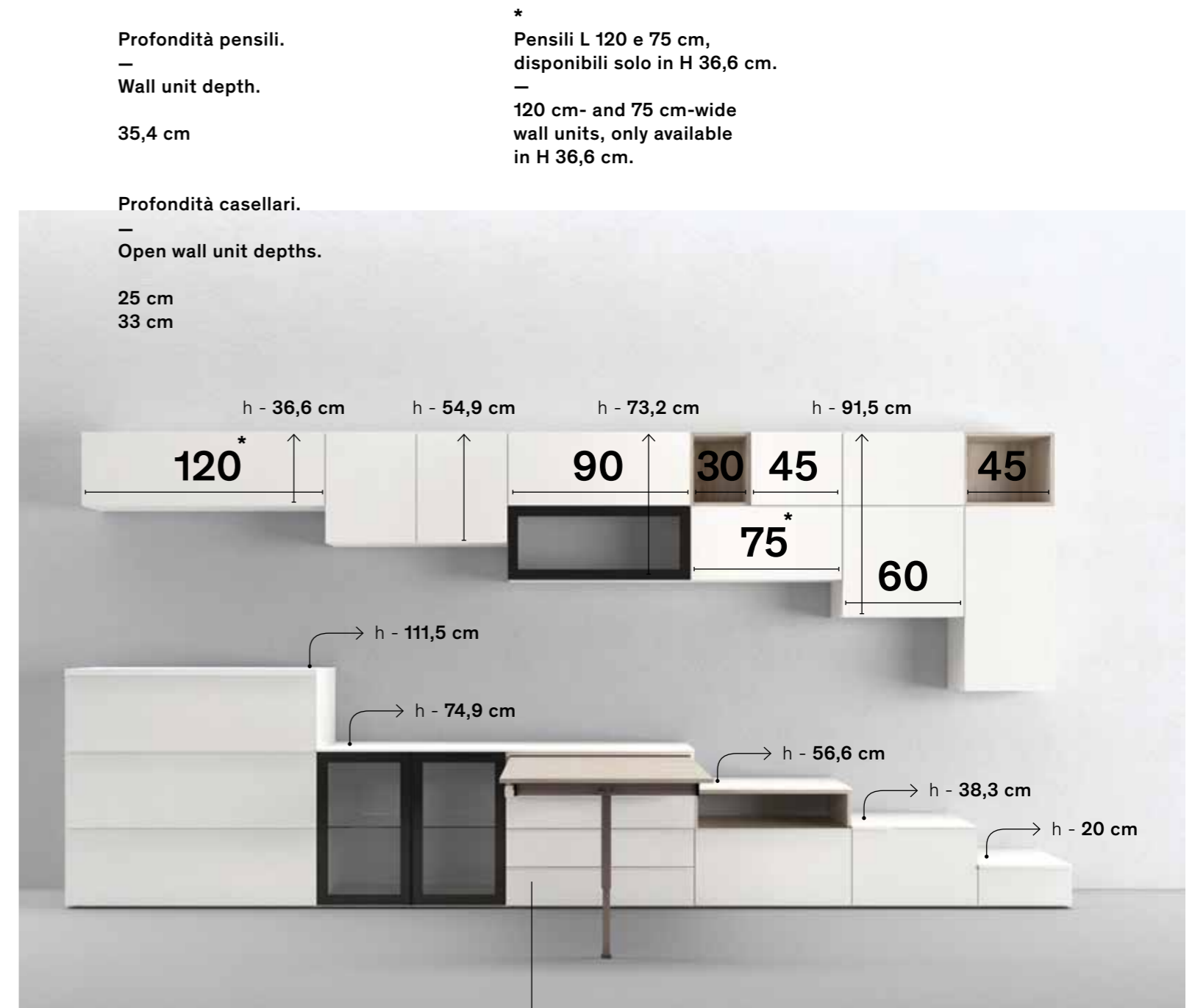



SISTEMA COVER — *panoramica*COVER SYSTEM — *overview*

INFO

Sistema Cover con pannelli a parete, mensole Cover Up e Cover Down, pomoli appendiabiti, mensole, mensole Elle, basi a terra e su ruote con top.

Cover system with wall-mounted panels, Cover Up and Cover Down shelves, clothes hanger knobs, shelves, Elle shelves, base units with top standing on the floor or castors.

INFO

Basi sospese solo P 45,8 cm (escluso H 19,3 cm) e P 35,8 cm.

Wall-mounted base units 45,8 cm (except H 19,3 cm) and 35,8 cm deep only.

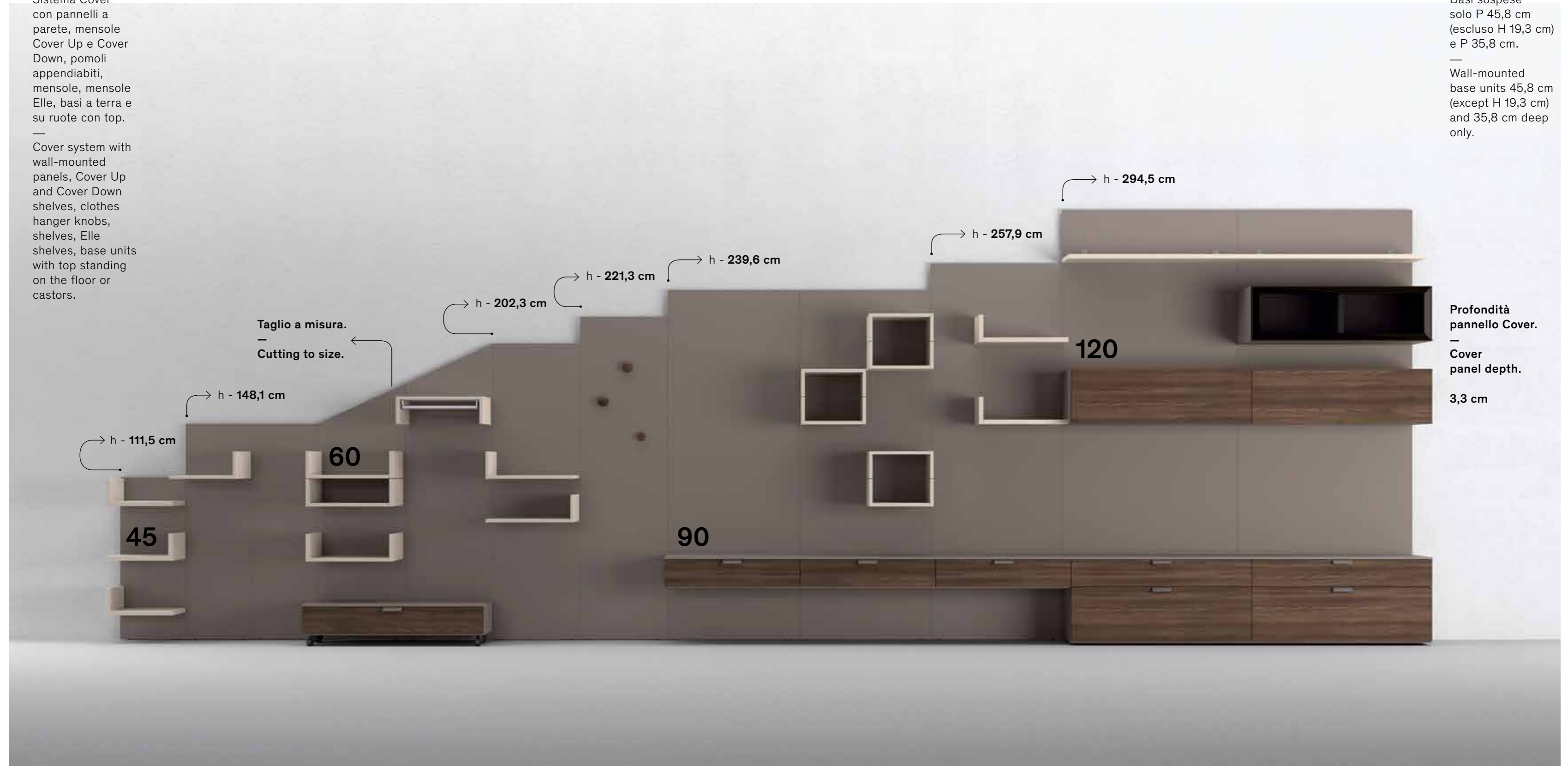

ATTREZZATURE PER ARMADI E CABINE ARMADIO — panoramica

WARDROBE AND WALK-IN CLOSET FITTINGS — overview



1.

Servetto
appendiabiti
estensibile.
—
Extending clothes
lift.

2.

Crociera interna.
—
Pigeon hole.

3.

Vassoi e vaschette
svuotatasche
estraibili.
—
Pull-out trays and
catchalls.

4.

Portapantaloni
estraibile.
—
Pull-out trouser
rack.

5.

Ripiano interno.
—
Internal shelf.

6.

Tubo appendiabiti.
—
Hanging rail.

7.

Cassettiera interna.
—
Internal drawer unit.

8.

Elemento estraibile
con 3 ripiani
orientabili.
—
Pull-out unit with 3
revolving racks.

9.

Porta cravatte
estraibile.
—
Pull-out tie rack.

10.

Cesto estraibile
in filo.
—
Pull-out wire
basket.

11.

Divisorio interno.
—
Internal partition.

12.

Portascarpe in
folding.
—
Mitre-folded shoe
rack.

13.

Sacca
portabiancheria
estraibile.
—
Pull-out fabric
laundry hamper.

Art direction and graphics
dogtrot

Images
Nerokubo

Colour separation and print
Lucegroup

March 2018



La qualità Cinquanta3
è certificata secondo le direttive
dell'Unione Eurasiatica.

—
Cinquanta3 quality is certified in
compliance with the Eurasian Union
technical regulations.

РЕГИСТРАЦИОННЫЙ НОМЕР ДЕКЛАРАЦИИ О
СООТВЕТСТВИИ:
TC N RU Д-ИТ.ГА02.В.03036/03037/03038/03039

Battistella spa si riserva in qualsiasi momento la facoltà di apportare tutte le modifiche necessarie al miglioramento funzionale e qualitativo dei propri prodotti. Per ogni aspetto tecnico, dimensionale e disponibilità finiture per ogni singolo articolo fare riferimento ai listini aziendali e relativi aggiornamenti. I colori e i materiali riprodotti nelle immagini stampate hanno un valore indicativo. Battistella spa declina ogni responsabilità derivante da eventuali inesattezze di stampa e/o da errori sulle caratteristiche dei prodotti forniti.

In line with its policy of improving product function and quality, Battistella spa reserves the right to make any necessary changes at any time. Please refer to our price lists and relevant updates for information of a technical and dimensional nature and to check what finishes are available for each item. The colours and materials reproduced in the images printed herein are given as an approximate guide only. Battistella spa does not accept any responsibility for misprints and/or mistakes in describing the characteristics of the products supplied.

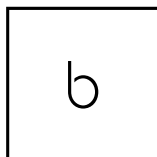

Battistella spa
via G. Galilei 35
31053 Pieve di Soligo
Treviso – Italia

T +39 0438 83 93
F +39 0438 83 95 55
info@cinquanta3.it
cinquanta3.it

